



ΕΚΔΟΣΗ | ISSUE

20



K. Theodosiadis sa

INOX FASTENERS • BOLTS - NUTS & NAUTICAL ACCESSORIES

All the stainless you need!

Κιγκαλερία | D.I.Y.

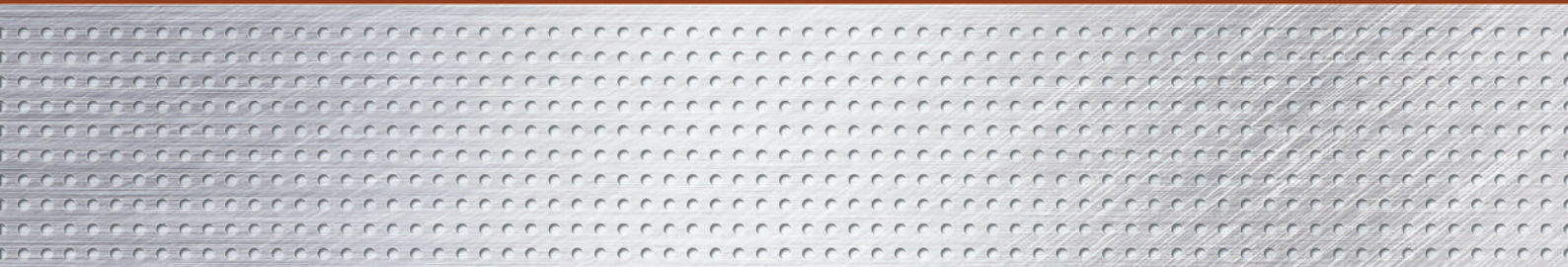

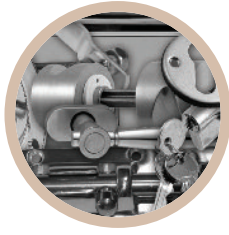

Κιγκαλερία | D.I.Y.

325

01	Χειρολαβές	Handles	326
	Χειρολαβές εξώπορτας	Pull handles	328
	Χειρολαβές γυάλινης πόρτας	Glass door pull handles	330
	Χειρολαβές επίπλου	Furniture handles	334
02	Πόμολα	Knobs	338
	Πόμολα επίπλου	Furniture knobs	338
	Πόμολα πόρτας	Door knobs	340
	Πόμολα μασίφ	Lever handles (solid)	341
	Πόμολα σωληνωτά	Lever handles (tube)	342
	Γρυλόχερα σωληνωτά	Window handles (tube)	342
	Πόμολα Olcese Ricci	Olcese Ricci handles	343
	Πόμολα Razeto & Casareto	Razeto & Casareto handles	344
03	Επιστόμια	Escutcheons	347
	Επιστόμια Razeto & Casareto	Razeto & Casareto escutcheons	347
	Επιστόμια Olcese Ricci	Olcese Ricci escutcheons	351
04	Κλειδαριές	Locks	352
	Κλειδαριές Olcese Ricci	Olcese Ricci locks	354
	Κλειδαριές Razeto & Casareto	Razeto & Casareto locks	356
	Κλείστρα ψυγείου Takigen	Takigen handles for airtightness	365
05	Μεντεσέδες	Hinges	366
	Μάσκουλα - Σπανιολέτες	Wooden door hinges - Espagnolettes	380
	Μεντεσέδες μέτρου	Continuous hinges	381
	Μεντεσέδες για κρύσταλλο	Shower hinges	382
	Σύστημα ανάκλισης γυάλινης πόρτας	Patch fittings	384
06	Κομπάσα	Hatch stays	385
07	Γωνίες	Brackets	389
08	Αξεσουάρ κουκέτας	Pulman bed accessories	390
	Κρεμαστράκια	Deck hooks	390
	Βάσεις	Bases	393
	Αξεσουάρ κουκέτας	Pulman bed accessories	394
09	Ζεμπερέκια	Door hooks	395
10	Σύρτες	Barell bolts	396
11	Χούφτες	Lift handles	398
12	Βάσεις πέργκολας	Pergola bases	403
13	Καταβάτες	Toggle latches	404
14	Στοπ πόρτας	Door holders	410
15	Σήματα πόρτας	Sign plates	412
16	Εξαρτήματα συρόμενης πόρτας	Sliding door hardware	413
17	Σιφώνια	Floor drains	414

Κιγκαλερία D.I.Y.

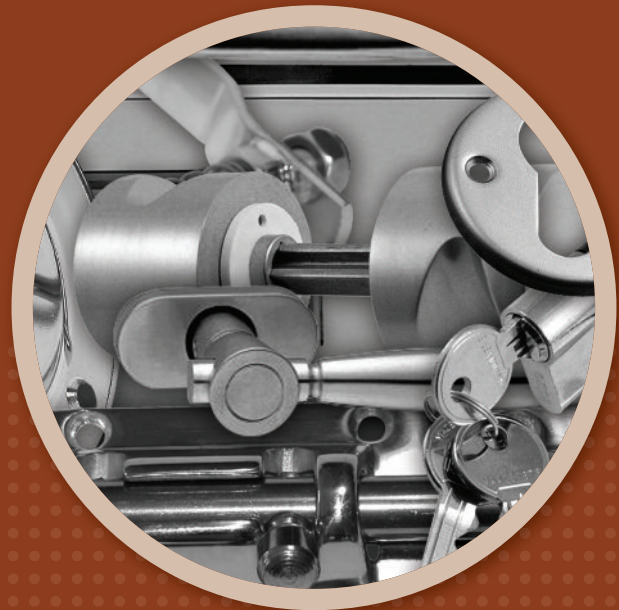

All the stainless you need!

01

Χειρολαβές Handles



33-0150

Χειρολαβή, Takigen, Ανοξείδωτη
Handle L200, Takigen, St. Steel

Διαστάσεις / Dim:
L200

TAKIGEN



33-0151

Χειρολαβή, Takigen, Ανοξείδωτη
Handle, Takigen, St. Steel

Διαστάσεις / Dim:
L320

TAKIGEN



33-0152

Χειρολαβή, Lamp, Ανοξείδωτη
Handle, Lamp, St. Steel

Διαστάσεις / Dim:
L320

LAMP
by SIGMA



33-0153

Χειρολαβή με πλάκα, Lamp, Ανοξείδωτη
Handle with plate, Lamp, St. Steel

Διαστάσεις / Dim:
L160 L200 L240 L320

LAMP
by SIGMA



33-0154

Χειρολαβή, Takigen, Ανοξείδωτη
Square shaped pulls, Takigen, St. Steel

Διαστάσεις / Dim:
L75 L117 L157 L245
L107 L127 L195 L295

TAKIGEN



33-0155

Χειρολαβή, Lamp, Ανοξείδωτη
Handle, Lamp, St. Steel

Διαστάσεις / Dim:
L118 L158 L238
L138 L188 L258

LAMP
by SIGMA

**33-0164**

Χειρολαβή, Lamp, Ανοξείδωτη - Πλαστική
 Furniture handle, Lamp, St. Steel - Plastic

Διαστάσεις / Dim:

L70	L120	L160
-----	------	------

**33-0165**

Χειρολαβή, Lamp, Ανοξείδωτη - Πλαστική
 Furniture handle, Lamp, St. Steel - Plastic

Διαστάσεις / Dim:

L210	L260
------	------

**33-0168**

Χειρολαβή, Emery, Ανοξείδωτη
 Handle, Emery, St. Steel

Διαστάσεις / Dim:

L150

LAMP
 by SCHMIDT

LAMP
 by SCHMIDT

**33-0240**

Χειρολαβή, satin, Ανοξείδωτη AISI 304
 Pull handle, satin, St. Steel AISI 304

Διαστάσεις / Dim:

Ø25-L228	Ø25-L406
Ø25-L305	Ø25-L457
Ø25-L356	

**33-0241**

Χειρολαβή, satin, Ανοξείδωτη AISI 304
 Handle, satin, St. Steel AISI 304

Διαστάσεις / Dim:

Ø19-L152/h56	Ø25-L305/h76
Ø19-L229/h56	Ø25-L457/h76
Ø19-L305/h56	Ø25-L610/h76
Ø19-L457/h63	Ø25-L762/h76
Ø19-L610/h63	Ø25-L914/h76

**33-0242**

Χειρολαβή, satin, Ανοξείδωτη AISI 304
 Handle, satin, St. Steel AISI 304

Διαστάσεις / Dim:

Ø19-60x180	Ø19-64x300
------------	------------

**33-0243**

Χειρολαβή Ø19mm, satin,
 Ανοξείδωτη AISI 304
 Handle Ø19mm, satin, St. Steel AISI 304

Διαστάσεις / Dim:

L152	L229	L305
------	------	------

**33-0244**

Χειρολαβή Ø19mm με ανοξείδωτη πλάκα,
 satin, Ανοξείδωτη AISI 304
 Handle Ø19mm with plate, satin,
 St. Steel AISI 304

Διαστάσεις / Dim:

L152 - Plate 250x76
L229 - Plate 330x76
L305 - Plate 400x76

**Χειρολαβές
εξώπορτας
Pull handles**



33-0301

Χειρολαβή εξώπορτας
μασίφ, satin,
Ανοξείδωτη AISI 304
Pull handle, solid, satin,
St. Steel AISI 304

Διαστάσεις / Dim:

Ø32 - A=350

Ø32 - A=450

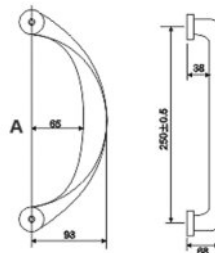

33-0302

Χειρολαβή εξώπορτας
μασίφ, satin,
Ανοξείδωτη AISI 304
Pull handle, solid, satin,
St. Steel AISI 304

Διαστάσεις / Dim:

L250



33-0303

Χειρολαβή εξώπορτας
μασίφ, satin,
Ανοξείδωτη AISI 304
Pull handle, solid, satin,
St. Steel AISI 304

Διαστάσεις / Dim:

L250

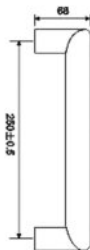

33-0304

Χειρολαβή εξώπορτας
μασίφ, satin,
Ανοξείδωτη AISI 304
Pull handle, solid, satin,
St. Steel AISI 304

Διαστάσεις / Dim:

L250

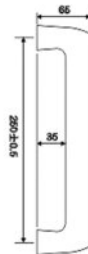

33-0305

Χειρολαβή εξώπορτας
μασίφ, satin,
Ανοξείδωτη AISI 304
Pull handle, solid, satin,
St. Steel AISI 304

Διαστάσεις / Dim:

L250

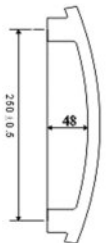

33-0306

Χειρολαβή εξώπορτας
μασίφ, satin,
Ανοξείδωτη AISI 304
Pull handle, solid, satin,
St. Steel AISI 304

Διαστάσεις / Dim:

L250



33-0307

Χειρολαβή εξώπορτας
μασίφ, satin,
Ανοξείδωτη AISI 304
Pull handle, solid, satin,
St. Steel AISI 304

Διαστάσεις / Dim:

L250



33-0308

Χειρολαβή εξώπορτας
μασίφ, satin,
Ανοξείδωτη AISI 304
Pull handle, solid, satin,
St. Steel AISI 304

Διαστάσεις / Dim:

L250

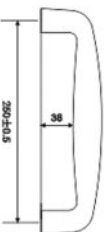

**33-0309**

Χειρολαβή εξώπορτας
μασίφ, satin,
Ανοξείδωτη AISI 304
Pull handle, solid, satin,
St. Steel AISI 304

Διαστάσεις / Dim:
L250

**33-0310**

Χειρολαβή εξώπορτας
μασίφ, satin,
Ανοξείδωτη AISI 304
Pull handle, solid, satin,
St. Steel AISI 304

Διαστάσεις / Dim:
L250

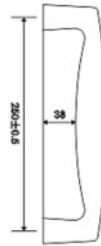
**33-0311**

Χειρολαβή εξώπορτας,
μασίφ, satin,
Ανοξείδωτη AISI 304
Pull handle, solid, satin,
St. Steel AISI 304

Διαστάσεις / Dim:
L250

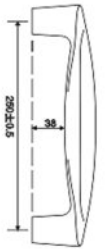
**33-0312**

Χειρολαβή εξώπορτας
μασίφ, satin,
Ανοξείδωτη AISI 304
Pull handle, solid, satin,
St. Steel AISI 304

Διαστάσεις / Dim:
L250

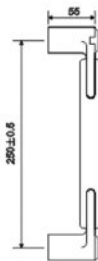
**33-0313**

Χειρολαβή εξώπορτας
μασίφ, satin,
Ανοξείδωτη AISI 304
Pull handle, solid, satin,
St. Steel AISI 304

Διαστάσεις / Dim:
L250

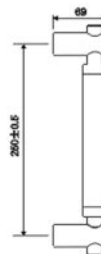
**33-0314**

Χειρολαβή εξώπορτας
μασίφ, satin,
Ανοξείδωτη AISI 304
Pull handle, solid, satin,
St. Steel AISI 304

Διαστάσεις / Dim:
L250

**33-0315**

Χειρολαβή εξώπορτας
μασίφ, satin,
Ανοξείδωτη AISI 304
Pull handle, solid, satin,
St. Steel AISI 304

Διαστάσεις / Dim:
L250

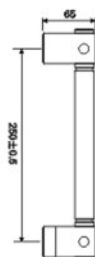
**33-0316**

Χειρολαβή εξώπορτας
μασίφ, satin,
Ανοξείδωτη AISI 304
Pull handle, solid, satin,
St. Steel AISI 304

Διαστάσεις / Dim:
L250

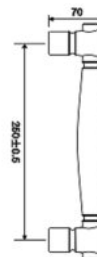

Χειρολαβές γυάλινης πόρτας Glass door pull handles



33-0201

Χειρολαβές (ζεύγος),
satin ή mirror,
Ανοξείδωτες AISI 304
Glass door pull handle
(pair), tube, satin or mirror,
St. Steel AISI 304

Διαστάσεις / Dim:

Ø32 - A=350
Ø32 - A=450

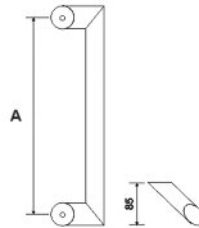

33-0202

Χειρολαβές (ζεύγος),
satin ή mirror,
Ανοξείδωτες AISI 304
Glass door pull handle
(pair), tube, satin or mirror,
St. Steel AISI 304

Διαστάσεις / Dim:

Ø32 - A=350
Ø32 - A=450

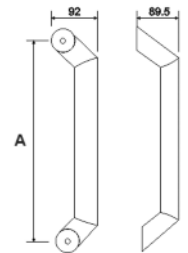

33-0203

Χειρολαβές (ζεύγος),
satin ή mirror,
Ανοξείδωτες AISI 304
Glass door pull handle
(pair), tube, satin or mirror,
St. Steel AISI 304

Διαστάσεις / Dim:

Ø32 - A=350
Ø32 - A=450

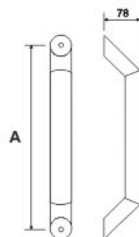

33-0205

Χειρολαβές (ζεύγος),
satin ή mirror,
Ανοξείδωτες AISI 304
Glass door pull handle
(pair), tube, satin or mirror,
St. Steel AISI 304

Διαστάσεις / Dim:

Ø32 - L400 - A=150
Ø38 - L400 - A=150

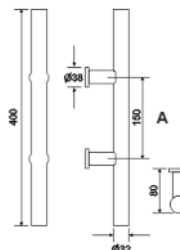

33-0206

Χειρολαβές (ζεύγος),
satin ή mirror,
Ανοξείδωτες AISI 304
Glass door pull handle
(pair), tube, satin or mirror,
St. Steel AISI 304

Διαστάσεις / Dim:

Ø32 - L400 - A=150
Ø38 - L400 - A=150

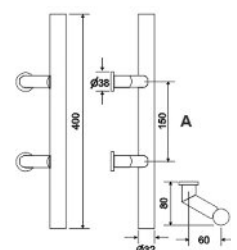

33-0207

Χειρολαβές (ζεύγος),
satin ή mirror,
Ανοξείδωτες AISI 304
Glass door pull handle
(pair), tube, satin or mirror,
St. Steel AISI 304

Διαστάσεις / Dim:

Ø38 - A=350

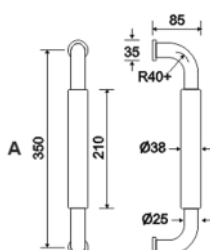

33-0208

Χειρολαβές (ζεύγος),
satin ή mirror,
Ανοξείδωτες AISI 304
Glass door pull handle
(pair), tube, satin or mirror,
St. Steel AISI 304

Διαστάσεις / Dim:

Ø38 - A=350

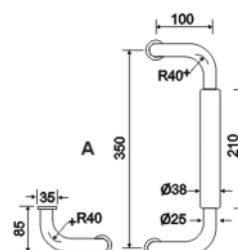

33-0209

Χειρολαβές (ζεύγος),
satin ή mirror,
Ανοξείδωτες AISI 304
Glass door pull handle
(pair), tube, satin or mirror,
St. Steel AISI 304

Διαστάσεις / Dim:

Ø32 - A=350
Ø38 - A=350

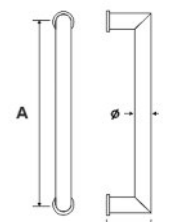

**33-0210**

Χειρολαβές (ζεύγος),
satin ή mirror,
Ανοξείδωτες AISI 304
Glass door pull handle
(pair), tube, satin or mirror,
St. Steel AISI 304

Διαστάσεις / Dim:

Ø32 - A=350

Ø32 - A=450

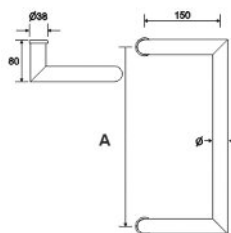
**33-0213**

Χειρολαβές (ζεύγος),
satin ή mirror,
Ανοξείδωτες AISI 304
Glass door pull handle
(pair), tube, satin or mirror,
St. Steel AISI 304

Διαστάσεις / Dim:

Ø22 - A=200 Ø32 - A=350

Ø25 - A=300 Ø38 - A=350

Ø25 - A=350

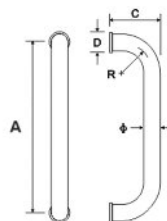
**33-0214**

Χειρολαβές (ζεύγος),
satin ή mirror,
Ανοξείδωτες AISI 304
Glass door pull handle
(pair), tube, satin or mirror,
St. Steel AISI 304

Διαστάσεις / Dim:

Ø25 - A=250

Ø32 - A=350

Ø38 - A=500

**33-0215**

Χειρολαβές (ζεύγος),
satin ή mirror,
Ανοξείδωτες AISI 304
Glass door pull handle
(pair), tube, satin or mirror,
St. Steel AISI 304

Διαστάσεις / Dim:

Ø22 - A=200 Ø32 - A=350

Ø25 - A=350 Ø38 - A=350

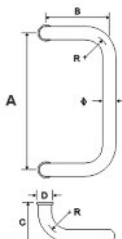
**33-0216**

Χειρολαβές (ζεύγος),
satin ή mirror,
Ανοξείδωτες AISI 304
Glass door pull handle
(pair), tube, satin or mirror,
St. Steel AISI 304

Διαστάσεις / Dim:

Ø22 - A=200 Ø32 - A=350

Ø25 - A=300 Ø38 - A=350

Ø25 - A=350

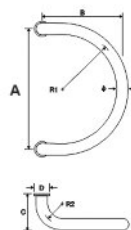
**33-0217**

Χειρολαβές (ζεύγος),
satin ή mirror,
Ανοξείδωτες AISI 304
Glass door pull handle
(pair), tube, satin or mirror,
St. Steel AISI 304

Διαστάσεις / Dim:

Ø22 - A=200 Ø32 - A=350

Ø25 - A=300 Ø38 - A=350

Ø25 - A=350

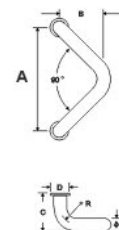
**33-0218**

Χειρολαβές (ζεύγος),
satin ή mirror,
Ανοξείδωτες AISI 304
Glass door pull handle
(pair), tube, satin or mirror,
St. Steel AISI 304

Διαστάσεις / Dim:

Ø38 - L647 - A=350

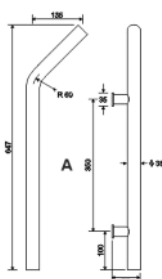
**33-0219**

Χειρολαβές (ζεύγος),
satin ή mirror,
Ανοξείδωτες AISI 304
Glass door pull handle
(pair), tube, satin or mirror,
St. Steel AISI 304

Διαστάσεις / Dim:

Ø38 - A=1000/220

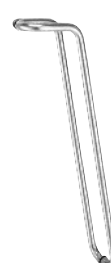
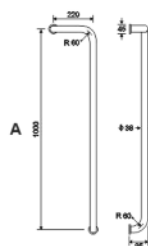
**33-0220**

Χειρολαβές (ζεύγος),
satin ή mirror,
Ανοξείδωτες AISI 304
Glass door pull handle
(pair), tube, satin or mirror,
St. Steel AISI 304

Διαστάσεις / Dim:

Ø38 - A=1000/474

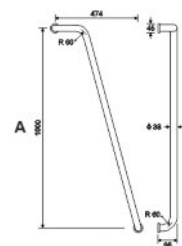

33-0221



Χειρολαβές (ζεύγος),
satin ή mirror,
Ανοξείδωτες AISI 304
Glass door pull handle
(pair), tube, satin or mirror,
St. Steel AISI 304

Διαστάσεις / Dim:
Ø25 - L390 - A=350

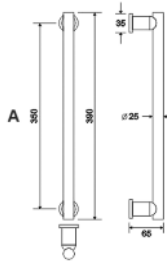

33-0222



Χειρολαβές (ζεύγος),
satin ή mirror,
Ανοξείδωτες AISI 304
Glass door pull handle
(pair), tube, satin or mirror,
St. Steel AISI 304

Διαστάσεις / Dim:
Ø25 - A=350

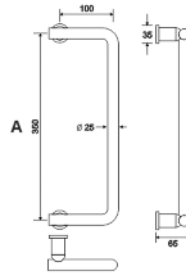

33-0223



Χειρολαβές (ζεύγος),
satin ή mirror,
Ανοξείδωτες AISI 304
Glass door pull handle
(pair), tube, satin or mirror,
St. Steel AISI 304

Διαστάσεις / Dim:
Ø25 - A=350

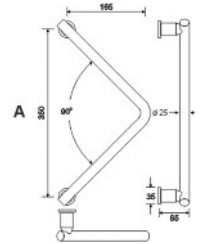

33-0224



Χειρολαβές (ζεύγος),
satin ή mirror,
Ανοξείδωτες AISI 304
Glass door pull handle
(pair), tube, satin or mirror,
St. Steel AISI 304

Διαστάσεις / Dim:
Ø25 - A=350

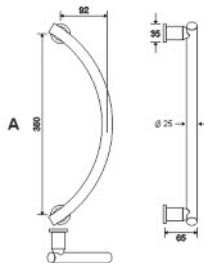

33-0225



Χειρολαβές (ζεύγος),
satin ή mirror,
Ανοξείδωτες AISI 304
Glass door pull handle
(pair), tube, satin or mirror,
St. Steel AISI 304

Διαστάσεις / Dim:
Ø25 - A=200

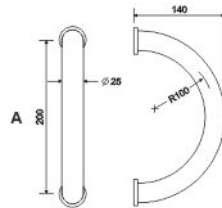

33-0227



Χειρολαβές (ζεύγος),
satin ή mirror,
Ανοξείδωτες AISI 304
Glass door pull handle
(pair), tube, satin or mirror,
St. Steel AISI 304

Διαστάσεις / Dim:
Ø25 - A=100

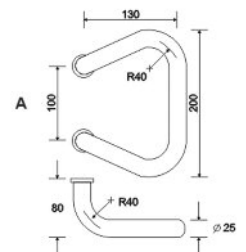

33-0228



Χειρολαβές (ζεύγος),
satin ή mirror,
Ανοξείδωτες AISI 304
Glass door pull handle
(pair), tube, satin or mirror,
St. Steel AISI 304

Διαστάσεις / Dim:
Ø25 - A=100

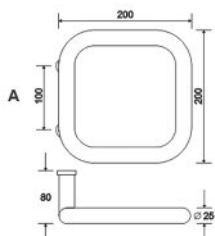

33-0229



Χειρολαβές (ζεύγος),
satin ή mirror,
Ανοξείδωτες AISI 304
Glass door pull handle
(pair), tube, satin or mirror,
St. Steel AISI 304

Διαστάσεις / Dim:
Ø25 - A=198

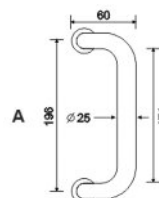

33-0230



Χειρολαβές (ζεύγος),
satin ή mirror,
Ανοξείδωτες AISI 304
Glass door pull handle
(pair), tube, satin or mirror,
St. Steel AISI 304

Διαστάσεις / Dim:
Ø25 - A=171

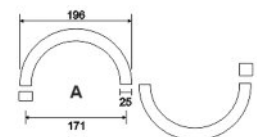

**33-0231**

Χειρολαβές (ζεύγος),
satin ή mirror,
Ανοξείδωτες AISI 304
Glass door pull handle
(pair), tube, satin or mirror,
St. Steel AISI 304

Διαστάσεις / Dim:

Ø38 - L408 - A=294

**33-0232**

Χειρολαβές (ζεύγος),
satin ή mirror,
Ανοξείδωτες AISI 304
Glass door pull handle
(pair), tube, satin or mirror,
St. Steel AISI 304

Διαστάσεις / Dim:

Ø25 - L610 - A=584

**33-0233**

Χειρολαβές (ζεύγος),
satin ή mirror,
Ανοξείδωτες AISI 304
Glass door pull handle
(pair), tube, satin or mirror,
St. Steel AISI 304

Διαστάσεις / Dim:

Ø32 - L610 - A=286

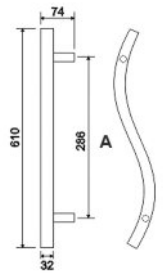
**33-0234**

Χειρολαβές (ζεύγος),
satin ή mirror,
Ανοξείδωτες AISI 304
Glass door pull handle
(pair), tube, satin or mirror,
St. Steel AISI 304

Διαστάσεις / Dim:

Ø25 - L305

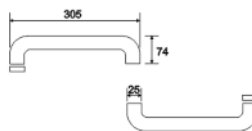

Χειρολαβές επίπλου Furniture handles



33-0101

Χειρολαβή επίπλου, Ανοξείδωτη AISI 304
Furniture handle, St. Steel AISI 304

Διαστάσεις / Dim:

L96	L128	L160
-----	------	------



33-0102

Χειρολαβή επίπλου, Ανοξείδωτη AISI 304
Furniture handle, St. Steel AISI 304

Διαστάσεις / Dim:

L96	L160	L256
L128	L192	L320



33-0103

Χειρολαβή επίπλου, Ανοξείδωτη AISI 304
Furniture handle, St. Steel AISI 304

Διαστάσεις / Dim:

L64	L192
L96	L256
L128	L320
L160	



33-0104

Χειρολαβή επίπλου, Ανοξείδωτη AISI 304
Furniture handle, St. Steel AISI 304

Διαστάσεις / Dim:

L96	L128	L160
-----	------	------



33-0105

Χειρολαβή επίπλου, Ανοξείδωτη AISI 304
Furniture handle, St. Steel AISI 304

Διαστάσεις / Dim:

L96	L128	L160
-----	------	------



33-0106

Χειρολαβή επίπλου, Ανοξείδωτη AISI 304
Furniture handle, St. Steel AISI 304

Διαστάσεις / Dim:

L96	L128	L160
-----	------	------



33-0107

Χειρολαβή επίπλου, Ανοξείδωτη AISI 304
Furniture handle, St. Steel AISI 304

Διαστάσεις / Dim:

L96	L128	L160
-----	------	------



33-0108

Χειρολαβή επίπλου, Ανοξείδωτη AISI 304
Furniture handle, St. Steel AISI 304

Διαστάσεις / Dim:

L96	L128	L160
-----	------	------

**33-0109**

Χειρολαβή επίπλου, Ανοξείδωτη AISI 304
 Furniture handle, St. Steel AISI 304

Διαστάσεις / Dim:

L96	L128	L160
-----	------	------

**33-0110**

Χειρολαβή επίπλου, Ανοξείδωτη AISI 304
 Furniture handle, St. Steel AISI 304

Διαστάσεις / Dim:

L96	L128	L160
-----	------	------

**33-0111**

Χειρολαβή επίπλου, Ανοξείδωτη AISI 304
 Furniture handle, St. Steel AISI 304

Διαστάσεις / Dim:

L96	L128	L160
-----	------	------

**33-0112**

Χειρολαβή επίπλου, Ανοξείδωτη AISI 304
 Furniture handle, St. Steel AISI 304

Διαστάσεις / Dim:

L96	L128	L160
-----	------	------

**33-0113**

Χειρολαβή επίπλου, Ανοξείδωτη AISI 304
 Furniture handle, St. Steel AISI 304

Διαστάσεις / Dim:

L96	L128	L160
-----	------	------

**33-0114**

Χειρολαβή επίπλου, Ανοξείδωτη AISI 304
 Furniture handle, St. Steel AISI 304

Διαστάσεις / Dim:

L96	L128	L160
-----	------	------

**33-0115**

Χειρολαβή επίπλου, Ανοξείδωτη AISI 304
 Furniture handle, St. Steel AISI 304

Διαστάσεις / Dim:

L96	L128	L160
-----	------	------

**33-0116**

Χειρολαβή επίπλου, Ανοξείδωτη AISI 304
 Furniture handle, St. Steel AISI 304

Διαστάσεις / Dim:

L96	L128	L160
-----	------	------

**33-0117**

Χειρολαβή επίπλου, Ανοξείδωτη AISI 304
 Furniture handle, St. Steel AISI 304

Διαστάσεις / Dim:

L96	L128	L160
-----	------	------



33-0118

Χειρολαβή επίπλου, Ανοξείδωτη AISI 304
Furniture handle, St. Steel AISI 304

Διαστάσεις / Dim:

L64 L96 L128 L160



33-0119

Χειρολαβή επίπλου, Ανοξείδωτη AISI 304
Furniture handle, St. Steel AISI 304

Διαστάσεις / Dim:

L64 L96 L128 L160



33-0120

Χειρολαβή επίπλου, Ανοξείδωτη AISI 304
Furniture handle, St. Steel AISI 304

Διαστάσεις / Dim:

L64 L96 L128 L160



33-0121

Χειρολαβή επίπλου, Ανοξείδωτη AISI 304
Furniture handle, St. Steel AISI 304

Διαστάσεις / Dim:

L64 L96 L128 L160



33-0122

Χειρολαβή επίπλου Ø8,
Ανοξείδωτη AISI 304
Furniture handle Ø8, St. Steel AISI 304

Διαστάσεις / Dim:

L96 L128 L160

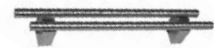

33-0123

Χειρολαβή επίπλου, Ανοξείδωτη AISI 304
Furniture handle, St. Steel AISI 304

Διαστάσεις / Dim:

L96 L128 L160



33-0124

Χειρολαβή επίπλου, Ανοξείδωτη AISI 304
Furniture handle, St. Steel AISI 304

Διαστάσεις / Dim:

L96 L128 L160



33-0125

Χειρολαβή επίπλου, Ανοξείδωτη AISI 304
Furniture handle, St. Steel AISI 304

Διαστάσεις / Dim:

L96 L128 L160



33-0156

Χειρολαβή επίπλου, Lamp, Ανοξείδωτη
Furniture handle, Lamp, St. Steel

Διαστάσεις / Dim:

L138 L165

LAMP
by DESIGN

**33-0157**

Χειρολαβή επίπλου, Lamp, Ανοξείδωτη
Furniture handle, Lamp, St. Steel

Διαστάσεις / Dim:

L115	L135	L165
------	------	------

LAMP
by SCHIENE

**33-0158**

Χειρολαβή επίπλου, Lamp, Ανοξείδωτη
Furniture handle, Lamp, St. Steel

Διαστάσεις / Dim:

L30	L50	L70	L90
-----	-----	-----	-----

LAMP
by SCHIENE

**33-0159**

Χειρολαβή επίπλου, Lamp, Ανοξείδωτη
Furniture handle, Lamp, St. Steel

Διαστάσεις / Dim:

L30	L70	L110	L150
L50	L90	L130	

LAMP
by SCHIENE

**33-0160**

Χειρολαβή επίπλου, Ανοξείδωτη
Furniture handle, St. Steel

Διαστάσεις / Dim:

L65	L80	L100
-----	-----	------

**33-0162**

Χειρολαβή επίπλου, Ανοξείδωτη
Furniture handle, St. Steel

Διαστάσεις / Dim:

L120

**33-0163**

Χειρολαβή επίπλου, Lamp, Ανοξείδωτη
Furniture handle, Lamp, St. Steel

Διαστάσεις / Dim:

L90	L110
-----	------

LAMP
by SCHIENE

**33-0167**

Χειρολαβή επίπλου, Lamp, Ανοξείδωτη
Furniture handle, Lamp, St. Steel

Διαστάσεις / Dim:

L145

LAMP
by SCHIENE

02 Πόμοια Knobs



Πόμοια επίπλου Furniture knobs

33-0100-031



Πόμοιο επίπλου,
Ανοξείδωτο AISI 304
Furniture knob,
St. Steel AISI 304

Διαστάσεις / Dim:

Ø10	Ø20	Ø30
Ø15	Ø25	Ø35

33-0100-032



Πόμοιο επίπλου,
Ανοξείδωτο AISI 304
Furniture knob,
St. Steel AISI 304

Διαστάσεις / Dim:

Ø10	Ø20	Ø30
Ø15	Ø25	Ø35

33-0100-033



Πόμοιο επίπλου,
Ανοξείδωτο AISI 304
Furniture knob,
St. Steel AISI 304

Διαστάσεις / Dim:

Ø10	Ø20	Ø30
Ø15	Ø25	Ø35

33-0100-034



Πόμοιο επίπλου,
Ανοξείδωτο AISI 304
Furniture knob,
St. Steel AISI 304

Διαστάσεις / Dim:

Ø10	Ø20	Ø30
Ø15	Ø25	Ø35

33-0100-035



Πόμοιο επίπλου,
Ανοξείδωτο AISI 304
Furniture knob,
St. Steel AISI 304

Διαστάσεις / Dim:

Ø10	Ø20	Ø30
Ø15	Ø25	Ø35

33-0100-036



Πόμοιο επίπλου,
Ανοξείδωτο AISI 304
Furniture knob,
St. Steel AISI 304

Διαστάσεις / Dim:

Ø10	Ø20	Ø30
Ø15	Ø25	Ø35

33-0100-037



Πόμοιο επίπλου,
Ανοξείδωτο AISI 304
Furniture knob,
St. Steel AISI 304

Διαστάσεις / Dim:

Ø10	Ø20	Ø30
Ø15	Ø25	Ø35

33-0100-038



Πόμοιο επίπλου,
Ανοξείδωτο AISI 304
Furniture knob,
St. Steel AISI 304

Διαστάσεις / Dim:

Ø10	Ø20	Ø30
Ø15	Ø25	Ø35

33-0100-039



Πόμοιο επίπλου,
Ανοξείδωτο AISI 304
Furniture knob,
St. Steel AISI 304

Διαστάσεις / Dim:

Ø10	Ø20	Ø30
Ø15	Ø25	Ø35

33-0100-040



Πόμοιο επίπλου,
Ανοξείδωτο AISI 304
Furniture knob,
St. Steel AISI 304

Διαστάσεις / Dim:

Ø10	Ø20	Ø30
Ø15	Ø25	Ø35

33-0100-041



Πόμοιο επίπλου,
Ανοξείδωτο AISI 304
Furniture knob,
St. Steel AISI 304

Διαστάσεις / Dim:

Ø10	Ø20	Ø30
Ø15	Ø25	Ø35

**33-0100-042**

Πόμολο επίπλου,
Ανοξείδωτο AISI 304
Furniture knob,
St. Steel AISI 304

Διαστάσεις / Dim:

Ø10	Ø20	Ø30
Ø15	Ø25	Ø35

**33-0100-043**

Πόμολο επίπλου,
Ανοξείδωτο AISI 304
Furniture knob,
St. Steel AISI 304

Διαστάσεις / Dim:

Ø10	Ø20	Ø30
Ø15	Ø25	Ø35

**33-0100-044**

Πόμολο επίπλου,
Ανοξείδωτο AISI 304
Furniture knob,
St. Steel AISI 304

Διαστάσεις / Dim:

Ø10	Ø20	Ø30
Ø15	Ø25	Ø35

**33-0100-045**

Πόμολο επίπλου,
Ανοξείδωτο AISI 304
Furniture knob,
St. Steel AISI 304

Διαστάσεις / Dim:

Ø10	Ø20	Ø30
Ø15	Ø25	Ø35

**33-0100-046**

Πόμολο επίπλου,
Ανοξείδωτο AISI 304
Furniture knob,
St. Steel AISI 304

Διαστάσεις / Dim:

Ø10	Ø20	Ø30
Ø15	Ø25	Ø35

**33-0100-047**

Πόμολο επίπλου,
Ανοξείδωτο AISI 304
Furniture knob,
St. Steel AISI 304

Διαστάσεις / Dim:

Ø10	Ø20	Ø30
Ø15	Ø25	Ø35

**33-0100-048**

Πόμολο επίπλου,
Ανοξείδωτο AISI 304
Furniture knob,
St. Steel AISI 304

Διαστάσεις / Dim:

Ø10	Ø20	Ø30
Ø15	Ø25	Ø35

**33-0100-049**

Πόμολο επίπλου,
Ανοξείδωτο AISI 304
Furniture knob,
St. Steel AISI 304

Διαστάσεις / Dim:

Ø10	Ø20	Ø30
Ø15	Ø25	Ø35

**33-0100-050**

Πόμολο επίπλου,
Ανοξείδωτο AISI 304
Furniture knob,
St. Steel AISI 304

Διαστάσεις / Dim:

Ø10	Ø20	Ø30
Ø15	Ø25	Ø35

**33-0100-051**

Πόμολο επίπλου,
Ανοξείδωτο AISI 304
Furniture knob,
St. Steel AISI 304

Διαστάσεις / Dim:

Ø10	Ø20	Ø30
Ø15	Ø25	Ø35

**33-0100-052**

Πόμολο επίπλου,
Ανοξείδωτο AISI 304
Furniture knob,
St. Steel AISI 304

Διαστάσεις / Dim:

Ø10	Ø20	Ø30
Ø15	Ø25	Ø35

**33-0100-053**

Πόμολο επίπλου,
Ανοξείδωτο AISI 304
Furniture knob,
St. Steel AISI 304

Διαστάσεις / Dim:

Ø10	Ø20	Ø30
Ø15	Ø25	Ø35

**33-0100-054**

Πόμολο επίπλου,
Ανοξείδωτο AISI 304
Furniture knob,
St. Steel AISI 304

Διαστάσεις / Dim:

Ø10	Ø20	Ø30
Ø15	Ø25	Ø35

**33-0100-057**

Πόμολο επίπλου,
Ανοξείδωτο AISI 304
Furniture knob,
St. Steel AISI 304

Διαστάσεις / Dim:

Ø10	Ø20	Ø30
Ø15	Ø25	Ø35

**33-0100-058**

Πόμολο επίπλου,
Ανοξείδωτο AISI 304
Furniture knob,
St. Steel AISI 304

Διαστάσεις / Dim:

Ø10	Ø20	Ø30
Ø15	Ø25	Ø35



33-0100-059

Πόμολο επίπλου,
Ανοξείδωτο AISI 304
Furniture knob,
St. Steel AISI 304

Διαστάσεις / Dim:

Ø10	Ø20	Ø30
Ø15	Ø25	Ø35



33-0100-063

Πόμολο επίπλου,
Ανοξείδωτο AISI 304
Furniture knob,
St. Steel AISI 304

Διαστάσεις / Dim:

Ø10	Ø20	Ø30
Ø15	Ø25	Ø35



33-0100-064

Πόμολο επίπλου,
Ανοξείδωτο AISI 304
Furniture knob,
St. Steel AISI 304

Διαστάσεις / Dim:

Ø10	Ø20	Ø30
Ø15	Ø25	Ø35



33-0100-065

Πόμολο επίπλου,
Ανοξείδωτο AISI 304
Furniture knob,
St. Steel AISI 304

Διαστάσεις / Dim:

Ø10	Ø20	Ø30
Ø15	Ø25	Ø35



33-0100-066

Πόμολο επίπλου,
Ανοξείδωτο AISI 304
Furniture knob,
St. Steel AISI 304

Διαστάσεις / Dim:

Ø10	Ø20	Ø30
Ø15	Ø25	Ø35



33-0100-067

Πόμολο επίπλου,
Ανοξείδωτο AISI 304
Furniture knob,
St. Steel AISI 304

Διαστάσεις / Dim:

Ø10	Ø20	Ø30
Ø15	Ø25	Ø35



33-0100-068

Πόμολο επίπλου,
Ανοξείδωτο AISI 304
Furniture knob,
St. Steel AISI 304

Διαστάσεις / Dim:

Ø10	Ø20	Ø30
Ø15	Ø25	Ø35



33-0100-069

Πόμολο επίπλου,
Ανοξείδωτο AISI 304
Furniture knob,
St. Steel AISI 304

Διαστάσεις / Dim:

Ø10	Ø20	Ø30
Ø15	Ø25	Ø35



33-0100-070

Πόμολο επίπλου,
Ανοξείδωτο AISI 304
Furniture knob,
St. Steel AISI 304

Διαστάσεις / Dim:

Ø10	Ø20	Ø30
Ø15	Ø25	Ø35



33-0100-071

Πόμολο επίπλου,
Ανοξείδωτο AISI 304
Furniture knob,
St. Steel AISI 304

Διαστάσεις / Dim:

Ø10	Ø20	Ø30
Ø15	Ø25	Ø35



33-0180

Πόμολο επίπλου,
Ανοξείδωτο
Furniture knob,
St. Steel

Διαστάσεις / Dim:

Ø25

**Πόμολα πόρτας
Door knobs**



33-0181

Πόμολο πόρτας,
Ανοξείδωτο
Door knob,
St. Steel

Διαστάσεις / Dim:

Ø38



33-0182

Πόμολο πόρτας με
ροζέτα,
Lamp, Ανοξείδωτο
Door knob with rosette,
Lamp, St. Steel

Διαστάσεις / Dim:

Ø25	Ø38
Ø32	Ø50



33-0183

Πόμολο πόρτας,
Ανοξείδωτο
Door knob,
St. Steel

Διαστάσεις / Dim:

Ø50	Ø63
-----	-----

Πόμολα μασίφ Lever handles (solid)



33-0601

Πόμολα μασίφ (ζεύγος),
Ανοξείδωτα AISI 304
Lever handles (pair), solid,
St. Steel AISI 304



33-0602

Πόμολα μασίφ (ζεύγος),
Ανοξείδωτα AISI 304
Lever handles (pair), solid,
St. Steel AISI 304



33-0603

Πόμολα μασίφ (ζεύγος),
Ανοξείδωτα AISI 304
Lever handles (pair), solid,
St. Steel AISI 304



33-0604

Πόμολα μασίφ (ζεύγος),
Ανοξείδωτα AISI 304
Lever handles (pair), solid,
St. Steel AISI 304



33-0605

Πόμολα μασίφ (ζεύγος),
Ανοξείδωτα AISI 304
Lever handles (pair), solid,
St. Steel AISI 304



33-0606

Πόμολα μασίφ (ζεύγος),
Ανοξείδωτα AISI 304
Lever handles (pair), solid,
St. Steel AISI 304



33-0607

Πόμολα μασίφ (ζεύγος),
Ανοξείδωτα AISI 304
Lever handles (pair), solid,
St. Steel AISI 304



33-0609

Πόμολα μασίφ (ζεύγος),
Ανοξείδωτα AISI 304
Lever handles (pair), solid,
St. Steel AISI 304



33-0645

Πόμολα μασίφ (ζεύγος),
Ανοξείδωτα AISI 304
Lever handles (pair), solid,
St. Steel AISI 304



33-0646

Πόμολα μασίφ (ζεύγος),
Ανοξείδωτα AISI 304
Lever handles (pair), solid,
St. Steel AISI 304



33-0647

Πόμολα μασίφ (ζεύγος),
Ανοξείδωτα AISI 304
Lever handles (pair), solid,
St. Steel AISI 304



33-0648

Πόμολα μασίφ στρογγυλά (ζεύγος),
Ανοξείδωτα AISI 304
Round lever handles (pair), solid,
St. Steel AISI 304



33-0643

Πόμολο μασίφ εξώπορτας,
Ανοξείδωτο AISI 304
Handle, solid, single,
St. Steel AISI 304

Πόμοια σωληνωτά Lever handles (tube)



33-0501

Πόμοια (ζεύγος), Ø19,
Ανοξείδωτα AISI 304
Lever handles (pair), tube,
St. Steel AISI 304



33-0502

Πόμοια (ζεύγος), Ø19,
Ανοξείδωτα AISI 304
Lever handles (pair), tube,
St. Steel AISI 304



33-0503

Πόμοια (ζεύγος), Ø19,
Ανοξείδωτα AISI 304
Lever handles (pair), tube,
St. Steel AISI 304



33-0504

Πόμοια (ζεύγος), Ø19,
Ανοξείδωτα AISI 304
Lever handles (pair), tube,
St. Steel AISI 304



33-0505

Πόμοια (ζεύγος), Ø19,
Ανοξείδωτα AISI 304
Lever handles (pair), tube,
St. Steel AISI 304

Γρυλόχερα σωληνωτά Window handles (tube)



33-0401

Γρυλόχερο σωληνωτό
WH-101, Ø19,
Ανοξείδωτο AISI 304
Window handle WH-101,
Ø19, tube,
St. Steel AISI 304



33-0402

Γρυλόχερο σωληνωτό
WH-102, Ø19,
Ανοξείδωτο AISI 304
Window handle WH-102,
Ø19, tube,
St. Steel AISI 304



33-0403

Γρυλόχερο σωληνωτό
WH-103, Ø19,
Ανοξείδωτο AISI 304
Window handle WH-103,
Ø19, tube,
St. Steel AISI 304



33-0404

Γρυλόχερο σωληνωτό
WH-104, Ø19,
Ανοξείδωτο AISI 304
Window handle WH-104,
Ø19, tube,
St. Steel AISI 304



33-0405

Γρυλόχερο σωληνωτό
WH-106, Ø19,
Ανοξείδωτο AISI 304
Window handle WH-106,
Ø19, tube,
St. Steel AISI 304



33-0406

Γρυλόχερο σωληνωτό
WH-107, Ø19,
Ανοξείδωτο AISI 304
Window handle WH-107,
Ø19, tube,
St. Steel AISI 304

**33-0408**

Γρυλόχερο σωληνωτό
WH-109, Ø19,
Ανοξείδωτο AISI 304
Window handle WH-109,
Ø19, tube,
St. Steel AISI 304

**33-0409**

Γρυλόχερο σωληνωτό
WH-110, Ø19,
Ανοξείδωτο AISI 304
Window handle WH-110,
Ø19, tube,
St. Steel AISI 304

**33-0410**

Γρυλόχερο σωληνωτό
WH-111, Ø19,
Ανοξείδωτο AISI 304
Window handle WH-111,
Ø19, tube,
St. Steel AISI 304

**33-0411**

Γρυλόχερο σωληνωτό
WH-112, Ø19,
Ανοξείδωτο AISI 304
Window handle WH-112,
Ø19, tube,
St. Steel AISI 304

**33-0412**

Γρυλόχερο σωληνωτό
WH-113, Ø19,
Ανοξείδωτο AISI 304
Window handle WH-113,
Ø19, tube,
St. Steel AISI 304

**33-0413**

Γρυλόχερο σωληνωτό
WH-114, Ø19,
Ανοξείδωτο AISI 304
Window handle WH-114,
Ø19, tube,
St. Steel AISI 304

**33-0415**

Γρυλόχερο σωληνωτό
WH-117, Ø19,
Ανοξείδωτο AISI 304
Window handle WH-117,
Ø19, tube,
St. Steel AISI 304

**33-0416**

Γρυλόχερο σωληνωτό
WH-118, Ø19,
Ανοξείδωτο AISI 304
Window handle WH-118,
Ø19, tube,
St. Steel AISI 304

**33-0417**

Γρυλόχερο σωληνωτό
WH-119, Ø19,
Ανοξείδωτο AISI 304
Window handle WH-119,
Ø19, tube,
St. Steel AISI 304

Πόμολα Olcese Ricci

Olcese Ricci handles

**35-2101**

Πόμολα (ζεύγος), Olcese Ricci, Αλουμίνιο
Handles (pair), Olcese Ricci, Aluminium

Διαστάσεις / Dim:
112x45 - □ 8mm

**35-2102**

Πόμολα (ζεύγος), Olcese Ricci, Αλουμίνιο
Handles (pair), Olcese Ricci, Aluminium

Διαστάσεις / Dim:
105x25 - □ 8mm



Πόμολα Razeto & Casareto Razeto & Casareto handles



33-1201



Πόμολο, πύρος 9mm, Razeto & Casareto,
Brass chrome plated
Handle, square 9mm, Razeto & Casareto,
Brass chrome plated

Ολικές διαστάσεις / Overall size:
110x60x20



33-1202



Πόμολο, πύρος 9mm, Razeto & Casareto,
Brass chrome plated
Handle, square 9mm, Razeto & Casareto,
Brass chrome plated

Ολικές διαστάσεις / Overall size:
105x53x17



33-1203



Πόμολο, πύρος 9mm, Razeto & Casareto,
Ανοξείδωτο
Handle, square 9mm, Razeto & Casareto,
St. Steel

Ολικές διαστάσεις / Overall size:
118x64x20



33-1204



Πόμολο, πύρος 9mm, Razeto & Casareto,
Brass chrome plated
Handle, square 9mm, Razeto & Casareto,
Brass chrome plated

Ολικές διαστάσεις / Overall size:
118x64x20



33-1205



Πόμολο, πύρος 9mm, Razeto & Casareto,
Brass chrome plated
Knob, square 9mm, Razeto & Casareto,
Brass chrome plated

Διαστάσεις / Knob size:
58x46



33-1206



Πόμολο για πόρτες πυρασφάλειας,
πύρος 9mm, Razeto & Casareto,
Ανοξείδωτο
Fire door handle, square 9mm,
Razeto & Casareto, St. Steel

Ολικές διαστάσεις / Overall size:
150x57x30



33-1207



Πόμολο για πόρτες πυρασφάλειας, πύρος
9mm, Razeto & Casareto,
Brass chrome plated
Fire door handle, square 9mm, Razeto &
Casareto, Brass chrome plated

Ολικές διαστάσεις / Overall size:
150x60x25



33-1208



Πόμολο για πόρτες πυρασφάλειας,
πύρος 9mm, Razeto & Casareto,
Brass chrome plated
Fire door handle, square 9mm, Razeto &
Casareto, Brass chrome plated

Ολικές διαστάσεις / Overall size:
150x57x30



33-1209

Πόμολο για πόρτες πυρασφάλειας,
 πύρος 9mm, Razeto & Casareto,
 Brass chrome plated
 Firedoor handle, square 9mm, Razeto &
 Casareto, Brass chrome plated

Ολικές διαστάσεις / Overall size:

117x53x17

**33-1210**

Πόμολο, πύρος 8mm, Razeto & Casareto,
 Brass chrome plated
 Handle, square 8mm, Razeto & Casareto,
 Brass chrome plated

Ολικές διαστάσεις / Overall size:

88x33

**33-1211**

Πόμολο, πύρος 8mm, Razeto & Casareto,
 Brass chrome plated
 Handle, square 8mm, Razeto & Casareto,
 Brass chrome plated

Ολικές διαστάσεις / Overall size:

84x38

**33-1212**

Πόμολο, πύρος 8mm, Razeto & Casareto,
 Brass chrome plated
 Handle, square 8mm, Razeto & Casareto,
 Brass chrome plated

Διαστάσεις / Knob size:

53x27 (h=33)

**33-1213**

Πόμολο, πύρος 8mm, Razeto & Casareto,
 Brass chrome plated
 Handle, square 8mm, Razeto & Casareto,
 Brass chrome plated

Διαστάσεις / Knob size:

53x27 (h=33, κρίκος/ring Ø34)

**33-1215**

Πόμολο, πύρος 8mm,
 Razeto & Casareto, Αλουμίνιο
 Knob, square 8mm, Razeto & Casareto,
 Anodised aluminium with nylon washers

Διαστάσεις / Dim:

Ø50xh40

**33-1217**

Πόμολο, πύρος 8mm, Razeto & Casareto,
 Brass chrome plated, ξύλο
 Handle, square 8mm, Razeto & Casareto,
 Brass chrome plated, wood

Διαστάσεις / Knob size:

80x30

**33-1218**

Πόμολο, πύρος 8mm, Razeto & Casareto,
 Brass chrome plated
 Handle, square 8mm, Razeto & Casareto,
 Brass chrome plated

Διαστάσεις / Knob size:

37x21 (h=31)

**33-1219**

Πόμολο, πύρος 8mm, Razeto & Casareto,
 Brass chrome plated
 Handle, square 8mm, Razeto & Casareto,
 Brass chrome plated

Διαστάσεις / Knob size:

Ø30 (h=33)

**33-1220**

Πόμολο 113mm, πύρος 9mm,
 Razeto & Casareto, Brass chrome plated
 Handle 113mm, square 9mm, Razeto &
 Casareto, Brass chrome plated



33-1221



Πόμολο, πύρος 8mm, Razeto & Casareto,
Brass chrome plated
Handle, square 8mm, Razeto & Casareto,
Brass chrome plated

Διαστάσεις / Knob size:
82x33



33-1222



Πόμολο, πύρος 8mm, Razeto & Casareto,
Brass chrome plated
Handle, square 8mm, Razeto & Casareto,
Brass chrome plated

Διαστάσεις / Knob size:
85x20



33-1224



Πόμολο, πύρος 8mm, Razeto & Casareto,
Brass chrome plated
Handle, square 8mm, Razeto & Casareto,
Brass chrome plated

Διαστάσεις / Knob size:
100x50



33-1230

Πόμολο δερμάτινο 7014,
Razeto & Casareto
Leather handle 7014,
Razeto & Casareto

Διαστάσεις / Knob size:
142x41



33-1231



Πόμολο, πύρος 8mm, Razeto & Casareto,
Brass chrome plated
Handle, square 8mm, Razeto & Casareto,
Brass chrome plated

Διαστάσεις / Knob size:
88x35



33-1232



Πόμολο, πύρος 8mm, Razeto & Casareto,
Brass chrome plated
Handle, square 8mm, Razeto & Casareto,
Brass chrome plated

Διαστάσεις / Knob size:
115x20



33-1233



Πόμολο, πύρος 8mm, Razeto & Casareto,
Brass chrome plated
Handle, square 8mm, Razeto & Casareto,
Brass chrome plated

Διαστάσεις / Knob size:
Ø50



33-1234

Πόμολο, πύρος 8mm, Razeto & Casareto,
Ανοξείδωτο AISI 316
Handle, square 8mm, Razeto & Casareto,
St. Steel AISI 316



33-1235



Πόμολο, πύρος 8mm, Razeto & Casareto,
Ανοξείδωτο AISI 316
Handle, square 8mm, Razeto & Casareto,
St. Steel AISI 316



03

Επιστόμια Escutcheons

**33-1333-1**

Επιστόμιο E1,
Ανοξείδωτο
Escutcheon E1,
St. Steel

**33-1333-4**

Επιστόμιο E4,
Ανοξείδωτο
Escutcheon E14,
Glory, St. Steel

**33-1333-6**

Επιστόμιο E6,
Ανοξείδωτο
Escutcheon E6,
St. Steel

Επιστόμια Razeto & Casareto Razeto & Casareto escutcheons

**33-1301**

Επιστόμια (ζεύγος),
Razeto & Casareto, Ανοξείδωτα
Escutcheons (pair),
Razeto & Casareto, St. Steel

Διαστάσεις / Dim:

196x38

**33-1302**

Επιστόμιο, Razeto & Casareto, Ανοξείδωτο
Escutcheon, Razeto & Casareto, St. Steel

Διαστάσεις / Dim:

196x38

**33-1303**

Επιστόμιο, Razeto & Casareto, Ανοξείδωτο
Escutcheon, Razeto & Casareto, St. Steel

Διαστάσεις / Dim:

196x38

**33-1304**

Επιστόμιο, Razeto & Casareto, Ανοξείδωτο
Escutcheon, Razeto & Casareto, St. Steel

Διαστάσεις / Dim:

196x38





33-1305

Επιστόμια (ζεύγος),
Razeto & Casareto, Ανοξείδωτα
Escutcheons (pair),
Razeto & Casareto, St. Steel

Διαστάσεις / Dim:
196x38



33-1306

Επιστόμια (ζεύγος),
Razeto & Casareto, Ανοξείδωτα
Escutcheons (pair),
Razeto & Casareto, St. Steel

Διαστάσεις / Dim:
190x50x5



33-1307

Επιστόμιο, Razeto & Casareto, Ανοξείδωτο
Escutcheon, Razeto & Casareto, St. Steel

Διαστάσεις / Dim:
190x50x5



33-1308

Επιστόμιο, Razeto & Casareto, Ανοξείδωτο
Escutcheon, Razeto & Casareto, St. Steel

Διαστάσεις / Dim:
190x50x5



33-1309

Επιστόμιο για πόρτες πυρασφάλειας,
Razeto & Casareto, Ανοξείδωτο
Firedoor escutcheon,
Razeto & Casareto, St. Steel

Διαστάσεις / Dim:
240x194



33-1310

Επιστόμιο για πόρτες πυρασφάλειας,
Razeto & Casareto, Ανοξείδωτο
Firedoor escutcheon,
Razeto & Casareto, St. Steel

Διαστάσεις / Dim:
240x194



33-1311

Επιστόμιο για πόρτες πυρασφάλειας,
Razeto & Casareto, Ανοξείδωτο
Firedoor escutcheon,
Razeto & Casareto, St. Steel

Διαστάσεις / Dim:
240x194x15



33-1312

Επιστόμιο, Razeto & Casareto, Ανοξείδωτο
Escutcheon, Razeto & Casareto, St. Steel

Διαστάσεις / Dim:
150x25 Ø18 για/for □ 9mm
 Ø13,5 για/for □ 8mm



33-1313

Επιστόμιο, Razeto & Casareto, Ανοξείδωτο
Escutcheon, Razeto & Casareto, St. Steel

Διαστάσεις / Dim:
135x25



33-1314

Επιστόμια (ζεύγος),
Razeto & Casareto, Ανοξείδωτα
Escutcheons (pair),
Razeto & Casareto, St. Steel

Διαστάσεις / Dim:
150x25 Ø18 για/for □ 9mm
 Ø13,5 για/for □ 8mm



**33-1315**

Επιστόμιο, Razeto & Casareto, Ανοξείδωτο
Escutcheon, Razeto & Casareto, St. Steel

Διαστάσεις / Dim:

150x25 Ø18 για/for □ 9mm
 Ø13,5 για/for □ 8mm

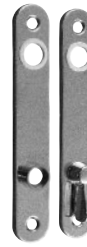
**33-1316**

Επιστόμια (ζεύγος),
Razeto & Casareto, Ανοξείδωτα
Escutcheons (pair),
Razeto & Casareto, St. Steel

Διαστάσεις / Dim:

150x25 Ø18 για/for □ 9mm
 Ø13,5 για/for □ 8mm

**33-1317**

Επιστόμιο, Razeto & Casareto,
Brass chrome plated
Escutcheon, Razeto & Casareto,
Brass chrome plated

Διαστάσεις / Dim:

135x25

**33-1318**

Επιστόμια (ζεύγος), Razeto & Casareto,
Brass chrome plated
Escutcheons (pair), Razeto & Casareto,
Brass chrome plated

Διαστάσεις / Dim:

135x25

**33-1319**

Επιστόμιο, Razeto & Casareto,
Brass chrome plated
Escutcheon, Razeto & Casareto,
Brass chrome plated

Διαστάσεις / Dim:

135x25

**33-1320**

Επιστόμιο, Razeto & Casareto,
Brass chrome plated
Escutcheon, Razeto & Casareto,
Brass chrome plated

Διαστάσεις / Dim:

230x30

**33-1321**

Επιστόμια (ζεύγος), Razeto & Casareto,
Brass chrome plated
Escutcheons (pair), Razeto & Casareto,
Brass chrome plated

Διαστάσεις / Dim:

Ø45

**33-1322**

Επιστόμιο, Razeto & Casareto,
Brass chrome plated
Escutcheon, Razeto & Casareto,
Brass chrome plated

Διαστάσεις / Dim:

53x28

**33-1323**

Επιστόμιο, Razeto & Casareto,
Brass chrome plated
Escutcheon, Razeto & Casareto,
Brass chrome plated

Διαστάσεις / Dim:

Ø45

**33-1324**

Επιστόμιο, Razeto & Casareto,
Brass chrome plated
Escutcheon, Razeto & Casareto,
Brass chrome plated

Διαστάσεις / Dim:

Ø60





33-1325

Επιστόμιο, Razeto & Casareto,
Brass chrome plated
Escutcheon, Razeto & Casareto,
Brass chrome plated

Διαστάσεις / Dim:
Ø60



33-1326

Επιστόμιο, Razeto & Casareto,
Brass chrome plated
Escutcheon, Razeto & Casareto,
Brass chrome plated

Διαστάσεις / Dim:
55x36



33-1327

Επιστόμιο, Razeto & Casareto,
Brass chrome plated
Escutcheon, Razeto & Casareto,
Brass chrome plated

Διαστάσεις / Dim:
55x36



33-1328

Επιστόμιο, Razeto & Casareto,
Brass chrome plated
Escutcheon, Razeto & Casareto,
Brass chrome plated

Διαστάσεις / Dim:
Ø45



33-1329

Επιστόμιο, Razeto & Casareto,
Brass chrome plated
Escutcheon, Razeto & Casareto,
Brass chrome plated

Διαστάσεις / Dim:
Ø45



33-1330

Επιστόμιο, Razeto & Casareto,
Brass chrome plated
Escutcheon, Razeto & Casareto,
Brass chrome plated

Διαστάσεις / Dim:
Ø32



33-1331

Επιστόμιο, Razeto & Casareto,
Brass chrome plated
Escutcheon, Razeto & Casareto,
Brass chrome plated

Διαστάσεις / Dim:
Ø32



33-1332

Επιστόμιο, Razeto & Casareto,
Ανοξείδωτο
Lock escutcheon with handle,
Razeto & Casareto, St. Steel

Διαστάσεις / Dim:
120x100



Επιστόμια Olcese Ricci

Olcese Ricci escutcheons



35-2483-1

Επιστόμιο, Olcese Ricci, Ανοξείδωτο
Escutcheon, Olcese Ricci, St. Steel

Διαστάσεις / Dim:
120x25



35-2483-2

Επιστόμιο, Olcese Ricci,
Chrome brass plated
Escutcheon, Olcese Ricci,
Chrome brass plated

Διαστάσεις / Dim:
120x25



35-2483-3

Επιστόμιο, Olcese Ricci, Ανοξείδωτο
Escutcheon, Olcese Ricci, St. Steel

Διαστάσεις / Dim:
120x25



35-2483-4

Επιστόμιο, Olcese Ricci, Ανοξείδωτο
Escutcheon, Olcese Ricci, St. Steel

Διαστάσεις / Dim:
120x25



35-2483-5

Επιστόμιο, Olcese Ricci, Ανοξείδωτο
Escutcheon, Olcese Ricci, St. Steel

Διαστάσεις / Dim:
120x25



35-2483-6

Επιστόμιο, Olcese Ricci, Ανοξείδωτο
Escutcheon, Olcese Ricci, St. Steel

Διαστάσεις / Dim:
164x25



35-2496

Επιστόμιο με πόμολο για WC,
Olcese Ricci, Ανοξείδωτο
Escutcheon with knob for WC,
Olcese Ricci, St. Steel

Διαστάσεις / Dim:
164x25



04 Κλειδαριές Locks



35-0001

Κλειδαριά με μαύρο στρογγυλό πόμολο, Select, Γαλλίας, Ανοξείδωτη
Lock with key and black knob, Select, France, St. Steel



35-4003

Κλειδαριά Omni Spring Bolt, Southco
Omni Spring Bolt lock, Southco

southco®

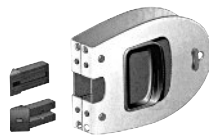

35-4005

Κλειδαριά Omni Bob, Southco
Omni Bob lock, Southco

southco®



35-4006

Κλειδαριά Omni Bob Single, Southco
Omni Bob Single lock, Southco

southco®

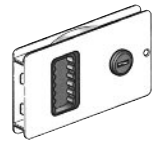

35-4008

Κλειδαριά Flush, Southco
Flush lock, Southco

Αλουμινίου, Ανοξείδωτη, Λευκή Μαύρη
Aluminium, St. Steel, White, Black

southco®

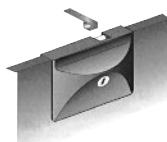

35-4009

Κλειδαριά Secure, Southco,
πλαστική, σε λευκό ή μαύρο
Secure lock, Southco, plastic,
in white or black

southco®

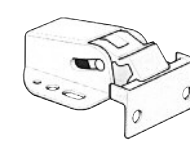

35-4101

Κλείστρο ντουλαπιού, Southco,
πλαστικό, σε λευκό ή καφέ
Lock for closet, Southco, plastic,
in white or brown

southco®



35-4102

Κλείστρο για ντουλάπια, Southco
Lock for closet, Southco

Χειρολαβή - καπάκι / Handle - cup:

Χρωμέ, σατινέ, μαύρο, άσπρο, μπρούτζινο
Chrome, satin, black, white, brass

southco®



35-4103

Κλείστρο για πόρτες, Southco
Lock for doors, Southco

Χειρολαβή - καπάκι / Handle - cup:

Χρωμέ, σατινέ, μαύρο, άσπρο, μπρούτζινο
Chrome, satin, black, white, brass

southco®

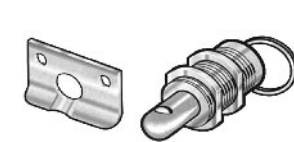

35-4104

Κλείστρο για λαζαρέτο, Roca, Ανοξείδωτο
Push lock, Roca, St. Steel

ROCA

**35-67202**

Κλειδαριά μπάνιου, Ανοξείδωτη
Lock, St. Steel

Διαστάσεις / Dim:
80x35

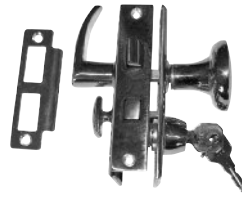
**35-67203**

Κλειδαριά καμπίνας με κλειδί, Ανοξείδωτη
Lock with key, St. Steel

Διαστάσεις / Dim:
70x50

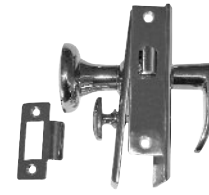
**35-67204**

Κλειδαριά καμπίνας με κλειδί & knob,
Ανοξείδωτη
Lock with key & knob, St. Steel

Διαστάσεις / Dim:
57x46

**35-6001**

Κλειδαριά Ξενοδοχείου Alpha 100
με κλειδί, Jaekel, Ανοξείδωτη
Lock Alpha 100 with key, Jaekel, St. Steel

Διαστάσεις / Dim:
Ø60

**35-6002**

Κλειδαριά Ξενοδοχείου, Ανοξείδωτη
Lock, St. Steel

Διαστάσεις / Dim:
Ø60

**35-6002-1**

Κλειδαριά Ξενοδοχείου
με κλειδί, Ανοξείδωτη
Lock with key, St. Steel

Διαστάσεις / Dim:
Ø60

**35-6004**

Κλειδαριά με λαβή για συρόμενη πόρτα,
Jaekel, Ανοξείδωτη
Lock with handle for sliding door,
Jaekel, St. Steel

**35-6005**

Push button, Lamp

Λευκό, Μαύρο, Νικελ Satin
White, Black, Nikel Satin

**33-2219-1**

Αφαλός, Ανοξείδωτος
Cylinder, St. Steel

LAMP
by SIGMA

**35-2016**

Mini push button, chrome or bronze
Mini push button, chrome or bronze

**35-2015**

NEW

Κλείστρο μπουτόν συρταριού, Razeto & Casareto, Ανοξείδωτο
Flush lock, Razeto & Casareto, St. Steel

Οβάλ, τετράγωνο, στογγυλό, τρίγωνο / Oval, square, round, triangle



Κλειδαριές Olcese Ricci Olcese Ricci locks

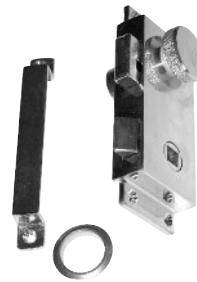

35-2001

Κλειδαριά με knob & κλειδί, Olcese Ricci, Chrome brass plated
Brass rim lock with cylinder from outside & turn knob from inside, Olcese Ricci, Chrome brass plated

Διαστάσεις κλειδαριάς / Lock dimensions:
110x45

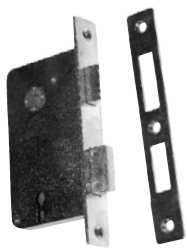

35-2002

Κλειδαριά πόρτας καμπίνας, Olcese Ricci, Chrome brass plated
Brass mortise lock complete with turn thumbs & flat striking plate, Olcese Ricci, Chrome brass plated

Διαστάσεις κλειδαριάς / Lock dimensions:
83x46

Διαστάσεις πλάκας / Face plate:
113x15



35-2008

Κλειδαριά πόρτας, Olcese Ricci, Chrome brass plated
Brass mortise lock complete with oval cylinders & flat striking plate, Olcese Ricci, Chrome brass plated

Διαστάσεις κλειδαριάς / Lock dimensions:
83x46

Διαστάσεις πλάκας / Face plate:
113x15

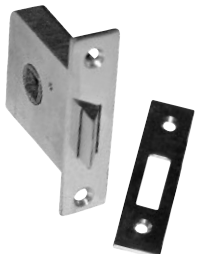

35-2003

Κλειδαριά πόρτας καμπίνας, Olcese Ricci, Chrome brass plated
Brass mortise lock complete with flat striking plate, Olcese Ricci, Chrome brass plated

Διαστάσεις κλειδαριάς / Lock dimensions:
46x30

Διαστάσεις πλάκας / Face plate:
66x16

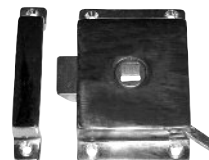

35-2004

Κλειδαριά μπάνιου, Olcese Ricci, Chrome brass plated
Brass rim lock complete with flat striking plate, Olcese Ricci, Chrome brass plated

Διαστάσεις κλειδαριάς / Lock dimensions:
75x50



35-2005

Κλειδαριά συρόμενης πόρτας, Olcese Ricci, Ανοξείδωτη
Door lock for sliding doors, Olcese Ricci, St. Steel

Διαστάσεις κλειδαριάς / Lock dimensions:
132x43

Διαστάσεις πλάκας / Face plate:
180x20



35-2007

Κλειδαριά με κύλινδρο, Olcese Ricci, Diecast brass plated with SS springs
Antirattle mortise lock with cylinder and flat striking plate, Olcese Ricci, Diecast brass plated with SS springs

Διαστάσεις κλειδαριάς / Lock dimensions:
132x70 Thickness: 10mm

Διαστάσεις πλάκας / Face plate:
182x70



**35-2014**

Κλειδαριά, Olcese Ricci,
Diecast brass plated with SS springs
Antirattle mortise lock with flat striking
plate, Olcese Ricci,
Diecast brass plated with SS springs

Διαστάσεις κλειδαριάς / Lock dimensions:

132x70 Thickness: 11mm

Διαστάσεις πλάκας / Face plate:

182x70

**35-2006**

Κλειδαριά με knob, Olcese Ricci,
Chrome brass plated
Brass mortise lock complete with flat
striking plate, cylinder from outside & turn
thumbs from inside, Olcese Ricci,
Chrome brass plated

Διαστάσεις κλειδαριάς / Lock dimensions:

53x62

**35-2009**

Push button, πλαστική βάση, με μπουτόν
σε χρωμέ, μπρονζέ ή άσπρο πλαστικό,
Olcese Ricci
Push button mechanism in white, with knob
in bronze, nickel or white, Olcese Ricci

**35-2010**

Push button, σπανιολέτα με 2 μέτρα ντίζα,
πλαστική βάση με μπουτόν σε χρωμέ,
μπρονζέ ή άσπρο πλαστικό, Olcese Ricci
Push button mechanism for doors in white,
with knob in bronze, nickel or white,
Olcese Ricci

**35-2011**

Πόμολο για Push
button, με δακτυλίδι
σε χρωμέ, μπρονζέ ή
άσπρο πλαστικό,
Olcese Ricci
Knob for push button
mechanism in white,
bronze or nickel,
Olcese Ricci

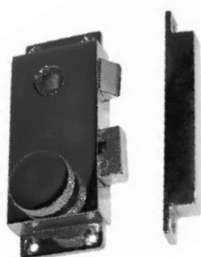
**35-2012**

Κλειδαριά με knob, Olcese Ricci,
Chrome brass plated
Lock with knob, Olcese Ricci,
Chrome brass plated

**35-2013**

Κλειδαριά εξωτερική με κύλινδρο Ø20,
Olcese Ricci, Ανοξείδωτος
Brass mortise lock complete with flat
striking plate Ø20, Olcese Ricci, St. Steel

Διαστάσεις κλειδαριάς / Lock dimensions:

62x53

**35-2017**

Κλειδαριά κωνευτή με μακρύ κλειδί, 11mm
πάχος, μηρούτζινη με ανοξείδωτα
ελατήρια, Olcese Ricci
Antirattle mortise lock complete with flat
striking plate and long key, thickness 11
mm. Diecast brass with St. Steel spring,
Olcese Ricci

**33-2019**

Αφαλός, Olcese Ricci, Ανοξείδωτος
Cylinder, Olcese Ricci, St. Steel





Κλειδαριές Razeto & Casareto Razeto & Casareto locks



351-2025

Κλειδαριά 2025, μόνο με αντίκρισμα, Razeto & Casareto, Ανοξείδωτη 2025 mortise lock with striker and hole for security cylinder, Razeto & Casareto, St. Steel

Διαστάσεις κλειδαριάς / Lock dimensions:
163x75x12

Διαστάσεις πλάκας / Face plate:
212x22x2



351-2035 (set)

Κλειδαριά 2035 (σετ), Razeto & Casareto, Ανοξείδωτη 2035 cylinder lock set with 3 keys, Razeto & Casareto, St. Steel

Διαστάσεις κλειδαριάς / Lock dimensions:
163x75x12

Διαστάσεις πλάκας / Face plate:
212x22x2

Επιστόμιο / Escutcheon:
196x38



351-2037

Κλειδαριά 2037, μόνο με αντίκρισμα, Razeto & Casareto, Ανοξείδωτη 2037 lock with striking plate, Razeto & Casareto, St. Steel

Διαστάσεις κλειδαριάς / Lock dimensions:
163x75x12

Διαστάσεις πλάκας / Face plate:
212x22x2



351-2037 (set)

Κλειδαριά 2037 (σετ), Razeto & Casareto, Ανοξείδωτη 2037 lock set, Razeto & Casareto, St. Steel

Διαστάσεις κλειδαριάς / Lock dimensions:
163x75x12

Διαστάσεις πλάκας / Face plate:
212x22x2

Επιστόμιο / Escutcheon:
196x38



351-2038

Κλειδαριά 2038, μόνο με αντίκρισμα, Razeto & Casareto, Ανοξείδωτη 2038 lock with striking plate, Razeto & Casareto, St. Steel

Διαστάσεις κλειδαριάς / Lock dimensions:
163x75x12

Διαστάσεις πλάκας / Face plate:
212x22x2

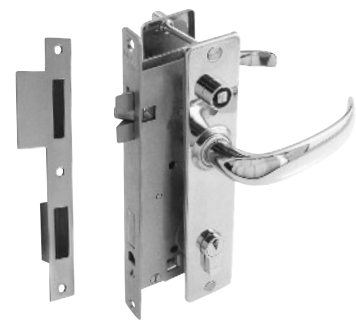

351-2038 (set)

Κλειδαριά 2038 (σετ), Razeto & Casareto, Ανοξείδωτη 2038 cylinder lock set with 3 keys & dead bolt, Razeto & Casareto, St. Steel

Διαστάσεις κλειδαριάς / Lock dimensions:
163x75x12

Διαστάσεις πλάκας / Face plate:
212x22x2

Επιστόμιο / Escutcheon:
196x38



**351-5039**

Κλειδαριά 5039, μόνο με αντίκρισμα,
 Razeto & Casareto, Ανοξείδωτη
 5039 lock with striking plate,
 Razeto & Casareto, St. Steel

Διαστάσεις κλειδαριάς / Lock dimensions:
 163x40x12

Διαστάσεις πλάκας / Face plate:
 212x22x2

**351-5040**

Κλειδαριά 5040, μόνο με αντίκρισμα,
 Razeto & Casareto, Ανοξείδωτη
 5040 lock with striking plate,
 Razeto & Casareto, St. Steel

Διαστάσεις κλειδαριάς / Lock dimensions:
 163x40x12

Διαστάσεις πλάκας / Face plate:
 212x22x2

**351-3474**

Κλειδαριά 3474, μόνο με αντίκρισμα,
 Razeto & Casareto, Ανοξείδωτη
 3474 lock with striking plate,
 Razeto & Casareto, St. Steel

Διαστάσεις κλειδαριάς / Lock dimensions:
 93x55x12

Διαστάσεις πλάκας / Face plate:
 133x15x2

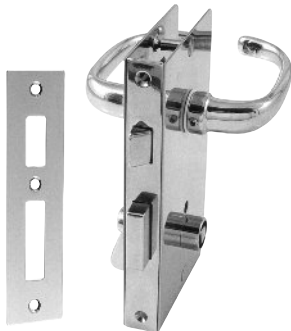
**351-4017 (set)**

Κλειδαριά 4017 (σετ),
 Razeto & Casareto, Ανοξείδωτη
 4017 mortise doorlock set with striker,
 escutcheon & handles,
 Razeto & Casareto, St. Steel

Διαστάσεις κλειδαριάς / Lock dimensions:
 98x58x15

Διαστάσεις πλάκας / Face plate:
 133x15x2

Επιστόμιο / Escutcheon:
 133x70

**351-4018 (set)**

Κλειδαριά 4018 (σετ),
 Razeto & Casareto, Ανοξείδωτη
 4018 mortise doorlock set with striker,
 escutcheon & handles,
 Razeto & Casareto, St. Steel

Διαστάσεις κλειδαριάς / Lock dimensions:
 98x58x15

Διαστάσεις πλάκας / Face plate:
 133x15x2

Επιστόμιο / Escutcheon:
 133x70

**351-4021**

Κλειδαριά 4021, μόνο με αντίκρισμα,
 Razeto & Casareto, Ανοξείδωτη
 4021 lock with striking plate & 2 keys,
 Razeto & Casareto, St. Steel

Διαστάσεις κλειδαριάς / Lock dimensions:
 93x44x12

Διαστάσεις πλάκας / Face plate:
 133x15x2



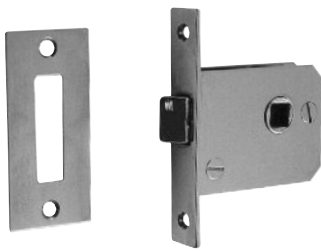

351-4023

Κλειδαριά 4023, μόνο με αντίκρισμα, Razeto & Casareto, Ανοξείδωτη 4023 lock with striking plate, Razeto & Casareto, St. Steel

Διαστάσεις κλειδαριάς / Lock dimensions:
44x42,5x12

Διαστάσεις πλάκας / Face plate:
85x15x2



351-4024

Κλειδαριά 4024, μόνο με αντίκρισμα, Razeto & Casareto, Ανοξείδωτη 4024 lock with striking plate & 2 keys, Razeto & Casareto, St. Steel

Διαστάσεις κλειδαριάς / Lock dimensions:
65x44x12

Διαστάσεις πλάκας / Face plate:
105x15x2



351-4025

Κλειδαριά 4025, μόνο με αντίκρισμα, Razeto & Casareto, Ανοξείδωτη 4025 lock with striking plate & 2 keys, Razeto & Casareto, St. Steel

Διαστάσεις κλειδαριάς / Lock dimensions:
65x58x12

Διαστάσεις πλάκας / Face plate:
105x15x2



351-4039

Κλειδαριά 4039, μόνο με αντίκρισμα, Razeto & Casareto, Ανοξείδωτη 4025 mortise lock with striking plate & 3 keys, Razeto & Casareto, St. Steel

Διαστάσεις κλειδαριάς / Lock dimensions:
163x75x15

Διαστάσεις πλάκας / Face plate:
212x22x2

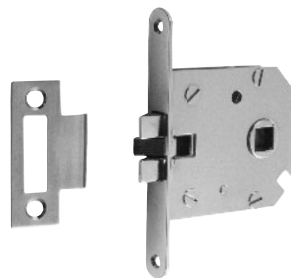

351-4097

Κλειδαριά 4097, μόνο με αντίκρισμα, Razeto & Casareto, Ανοξείδωτη 4097 lock with striking plate, Razeto & Casareto, St. Steel

Διαστάσεις κλειδαριάς / Lock dimensions:
76x60x13

Διαστάσεις πλάκας / Face plate:
110x15x2



351-203120 (set)

Κλειδαριά 203120 (σετ), Razeto & Casareto, Ανοξείδωτη 203120 only handle lock set, Razeto & Casareto, St. Steel

Διαστάσεις κλειδαριάς / Lock dimensions:
95x75x15

Διαστάσεις πλάκας / Face plate:
144x22x2



**351-3486**

Κλειδαριά 3486,
Razeto & Casareto, Ανοξείδωτη
3486 lock with striking plate,
Razeto & Casareto, St. Steel

Διαστάσεις κλειδαριάς / Lock dimensions:
57x42,5x12

Διαστάσεις πλάκας / Face plate:
80x15x2

**351-3476**

Κλειδαριά 3476,
Razeto & Casareto, Ανοξείδωτη
3476 lock with striking plate & 2 keys,
Razeto & Casareto, St. Steel

Διαστάσεις κλειδαριάς / Lock dimensions:
93x55x12

Διαστάσεις πλάκας / Face plate:
133x15x2

**351-3452**

Κλειδαριά 3452,
Razeto & Casareto, Ανοξείδωτη
3452 lock with stop lever & stricker,
Razeto & Casareto, St. Steel

Διαστάσεις εξωτερικές ολικές / Overall Dimension:
98x58x15

**351-3484**

Κλειδαριά 3484,
Razeto & Casareto, Ανοξείδωτη
3484 lock with 2 keys & stricker,
Razeto & Casareto, St. Steel

Διαστάσεις εξωτερικές ολικές / Overall Dimension:
138x58x15

**351-3985**

Κλειδαριά 3985,
Razeto & Casareto, Ανοξείδωτη
3985 lock with 3 keys & stricker,
Razeto & Casareto, St. Steel

Διαστάσεις εξωτερικές ολικές / Overall Dimension:
186x77x18

**351-3986**

Κλειδαριά 3986,
Razeto & Casareto, Ανοξείδωτη
3986 lock with hole for security cylinder &
striking plate, Razeto & Casareto, St. Steel

Διαστάσεις εξωτερικές ολικές / Overall Dimension:
186x77x18





351-4030

Κλειδαριά 4030,
Razeto & Casareto, Ανοξείδωτη
4030 lock with striker & locking knob,
Razeto & Casareto, St. Steel

**Διαστάσεις εξωτερικές ολικές /
Overall Dimension:**

186x77x18

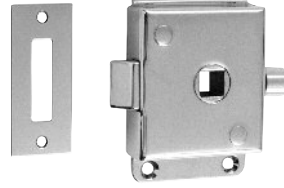

351-4061

Κλειδαριά 4061,
Razeto & Casareto, Ανοξείδωτη
4061 lock with stop lever & striking plate,
Razeto & Casareto, St. Steel

**Διαστάσεις εξωτερικές ολικές /
Overall Dimension:**

72x46x15



351-4062

Κλειδαριά 4062,
Razeto & Casareto, Ανοξείδωτη
4062 lock with 2 keys & striker,
Razeto & Casareto, St. Steel

**Διαστάσεις εξωτερικές ολικές /
Overall Dimension:**

112x46x15

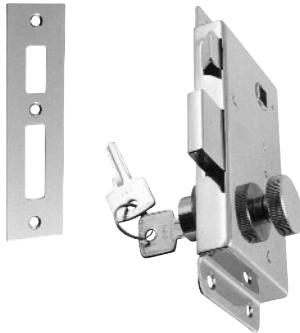

351-3475

Κλειδαριά 3475,
Razeto & Casareto, Ανοξείδωτη
3475 lock with 2 trip bolts, knupled knob,
security cylinder with 2 keys & striker,
Razeto & Casareto, St. Steel

**Διαστάσεις εξωτερικές ολικές /
Overall Dimension:**

138x58x15



351-3985

Κλειδαριά 3985, Razeto & Casareto,
Chrome brass, κούφρα Ανοξείδωτη
3985 lock with 3 keys & striker, Razeto &
Casareto, Chrome brass, St. Steel lift handle

Διαστάσεις κλειδαριάς / Lock dimensions:

186x77x18



351-3113

Κλειδαριά 3113, Razeto & Casareto,
Chrome brass, κούφρα Ανοξείδωτη
3113 rim lever lock, Razeto & Casareto,
Chrome brass, St. Steel lift handle

Διαστάσεις / Dim:

73x34

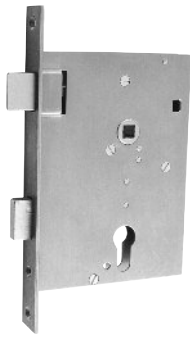

**351-503612**

Κλειδαριά 503612,
Razeto & Casareto, Ανοξείδωτη
503612 lock with 1 locking point,
Razeto & Casareto, St. Steel

Διαστάσεις κλειδαριάς / Lock dimensions:

163x119x15

Διαστάσεις πλάκας / Face plate:

220x25x3

**351-3373**

Κλειδαριά 3373,
Razeto & Casareto, Ανοξείδωτη
3373 lock with St. Steel hook & hole
for security cylinder,
Razeto & Casareto, St. Steel

Διαστάσεις κλειδαριάς / Lock dimensions:

153x83x14

Διαστάσεις πλάκας / Face plate:

225x22x4

**351-3448 (set)**

Κλειδαριά 3448 (σετ),
Razeto & Casareto, Ανοξείδωτη
3448 lock set with St. Steel escutcheons &
flush handles, striking plate & 2 keys,
Razeto & Casareto, St. Steel

**351-3487**

Κλειδαριά 3487,
Razeto & Casareto, Ανοξείδωτη
3487 lock with striking plate & hole
for security cylinder,
Razeto & Casareto, St. Steel

**351-3786**

Κλειδαριά 3786,
Razeto & Casareto, Ανοξείδωτη
3786 lock with St. Steel hook & security
cylinder, Razeto & Casareto, St. Steel

Διαστάσεις κλειδαριάς / Lock dimensions:

220x22

**351-3796**

Κλειδαριά 3796,
Razeto & Casareto, Ανοξείδωτη
3796 lock with escutcheons, flush handles &
striking plate, Razeto & Casareto, St. Steel





351-3799

Κλειδαριά 3799, Razeto & Casareto, Ανοξείδωτη 3799 lock with striking plate & hole for security cylinder, Razeto & Casareto, St. Steel

Διαστάσεις κλειδαριάς / Lock dimensions:

194x63x15

Διαστάσεις πλάκας / Face plate:

250x25x3



351-3838

Κλειδαριά 3838, Razeto & Casareto, Ανοξείδωτη 3838 lock with St. Steel escutcheons, flush handles, striking plate, locking knob inside, Razeto & Casareto, St. Steel

351-4070

Κλειδαριά 4070, Razeto & Casareto, Ανοξείδωτη 4070 lock with striking plate & 2 keys, Razeto & Casareto, St. Steel

Διαστάσεις κλειδαριάς / Lock dimensions:

101x43x12

Διαστάσεις πλάκας / Face plate:

140x15x2

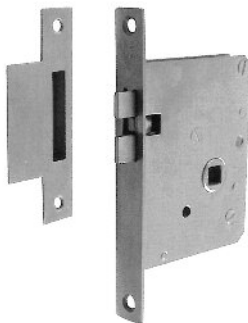

351-2021

Κλειδαριά 2021, Razeto & Casareto, Brass chrome plated 2021 lock with striking plate, Razeto & Casareto, Brass chrome plated

Διαστάσεις κλειδαριάς / Lock dimensions:

95x75x13

Διαστάσεις πλάκας / Face plate:

144x18x2



351-379940

Κλειδαριά συρόμενης πόρτας 379940, Razeto & Casareto, St. Steel 379940 lock for sliding door, Razeto & Casareto, St. Steel

Διαστάσεις κλειδαριάς / Lock dimensions:

194x61x15

Διαστάσεις πλάκας / Face plate:

250x25x13



351-3829

Κλειδαριά συρόμενης πόρτας 3829, Razeto & Casareto, Brass chrome plated 3829 lock for sliding door, Razeto & Casareto, Brass chrome plated



**351-3830**

Κλειδαριά συρόμενης πόρτας 3830,
 Razeto & Casareto, Brass chrome plated
 3830 lock for sliding door,
 Razeto & Casareto, Brass chrome plated

**351-7015 (set)**

Κλειδαριά 7015 (σετ),
 Razeto & Casareto, Brass chrome plated
 7015 lock (set), Razeto & Casareto,
 Brass chrome plated

**351-701504 (set)**

Κλειδαριά 701504 (σετ),
 Razeto & Casareto, Brass chrome plated
 701504 lock (set), Razeto & Casareto,
 Brass chrome plated

**351-701508 (set)**

Κλειδαριά 701504 (σετ),
 Razeto & Casareto, Brass chrome plated
 701508 lock (set), Razeto & Casareto,
 Brass chrome plated

**351-7016 (set)**

Κλειδαριά 7016 (σετ),
 Razeto & Casareto, Brass chrome plated
 7016 lock (set), Razeto & Casareto,
 Brass chrome plated

**351-7030**

Κλειδαριά φάλκας 7030,
 Razeto & Casareto, Brass chrome plated
 7030 lock for sliding door,
 Razeto & Casareto, Brass chrome plated





351-3456

Αφαλός ασφαλείας με 3 κλειδιά,
Razeto & Casareto
Security cylinder with 3 keys,
Razeto & Casareto, St. Steel

Διαστάσεις / Dim:

L45 L56 L70



351-3977

Αφαλός ασφαλείας με knob με 3 κλειδιά,
Razeto & Casareto
Cylinder with 3 keys & knob,
Razeto & Casareto

Διαστάσεις / Dim:

L56 L70



351-4035

Αφαλός ασφαλείας με 3 κλειδιά,
Razeto & Casareto
Security cylinder with 3 keys,
Razeto & Casareto

Διαστάσεις / Dim:

L61 28/33
L70 30/40
L80 30/50
L90 30/60
L100 30/80



Hinges-mortise locks

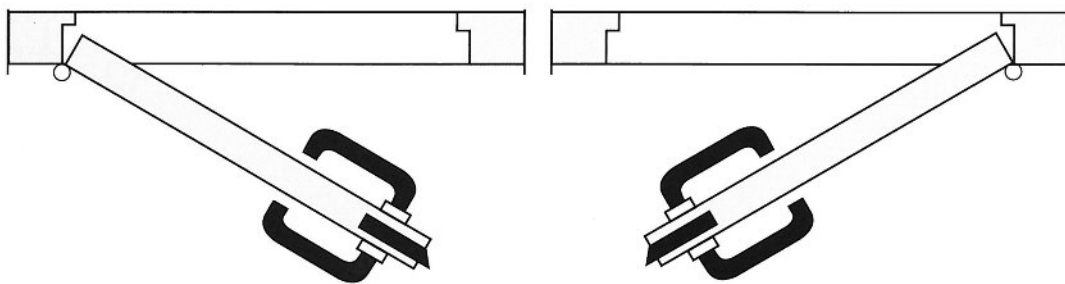

left

right

Rim locks

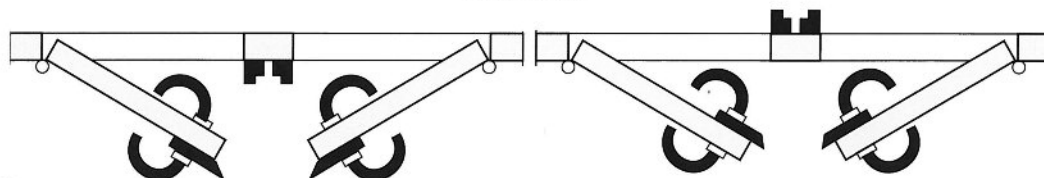

left inside

right inside

left outside

right outside

Κλείστρα ψυγείου

Handles for airtightness

TAKIGEN



33-1701

Κλείστρο ψυγείου, Takigen, Ανοξείδωτο
Handle for airtightness, Takigen, St. Steel

Διαστάσεις / Dim (WxL):
52x157

TAKIGEN



33-1702

Κλείστρο ψυγείου, Takigen, Ανοξείδωτο
Handle for airtightness, Takigen, St. Steel

Διαστάσεις / Dim (WxL):
52x170

TAKIGEN



33-1703

Κλείστρο ψυγείου, Takigen, Ανοξείδωτο
Handle for airtightness, Takigen, St. Steel

Διαστάσεις / Dim (WxL):
52x210

TAKIGEN



33-1704

Κλείστρο ψυγείου, Takigen, Ανοξείδωτο
Roller latch handle for airtightness,
Takigen, St. Steel

Διαστάσεις / Dim (WxL):
56x133

TAKIGEN



33-1705

Κλείστρο ψυγείου, Takigen, Ανοξείδωτο
Roller latch handle for airtightness,
Takigen, St. Steel

Διαστάσεις / Dim (WxL):
55x156

TAKIGEN



33-1706

Κλείστρο ψυγείου, Takigen, Ανοξείδωτο
Roller latch handle for airtightness,
Takigen, St. Steel

Διαστάσεις / Dim (WxL):
76x180

TAKIGEN



33-1720

Κλείστρο ψυγείου, Takigen, Ανοξείδωτο
Corner handle, Takigen, St. Steel

Διαστάσεις / Dim (WxL):
20x155

TAKIGEN



33-1721

Κλείστρο ψυγείου, Takigen, Ανοξείδωτο
Corner handle, Takigen, St. Steel

Διαστάσεις / Dim (WxL):
17x150

TAKIGEN



33-1730

Κλείστρο ψυγείου κωνευτό με κλειδί,
Takigen, Ανοξείδωτο
Latch type flush handle with key,
Takigen, St. Steel

TAKIGEN

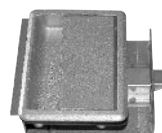

33-1731

Κλείστρο ψυγείου κωνευτό,
Takigen, Ανοξείδωτο
Latch type flush handle,
Takigen, St. Steel

TAKIGEN

05

Μεντεσέδες Hinges



34-0101

Μεντεσές χυτός "Τ", Ανοξείδωτος AISI 316
"T" strap hinge, St. Steel AISI 316

Διαστάσεις / Dim (WxLxTh):

58x98x4 74x147x4 97x195x4



34-0102

Μεντεσές χυτός "Τ", Ανοξείδωτος AISI 304
"T" strap hinge, St. Steel AISI 304

Διαστάσεις / Dim (WxLxTh):

89x179x2



34-0103

Μεντεσές χυτός, Ανοξείδωτος AISI 316
Door hinge, St. Steel AISI 316

Διαστάσεις / Dim (WxLxTh):

38x74x4



34-0104

Μεντεσές χυτός, Ανοξείδωτος AISI 316
Door hinge, St. Steel AISI 316

Διαστάσεις / Dim (WxLxTh):

38x104x4



34-0105

Μεντεσές χυτός, Ανοξείδωτος AISI 316
Door hinge, St. Steel AISI 316

Διαστάσεις / Dim (WxLxTh):

64x145x4



34-0106

Μεντεσές χυτός, Ανοξείδωτος AISI 316
Door hinge, St. Steel AISI 316

Διαστάσεις / Dim (WxLxTh):

20x144x4



34-0107

Μεντεσές χυτός, Ανοξείδωτος AISI 316
Butt hinge, St. Steel AISI 316

Διαστάσεις / Dim (WxLxTh):

37x40x4 50x50x4



34-0108

Μεντεσές χυτός, ψυγείου,
Ανοξείδωτος AISI 316
Hinge, St. Steel AISI 316

Διαστάσεις / Dim (WxLxTh):

82x137x4



34-0109

Μεντεσές χυτός, Ανοξείδωτος AISI 316
Door hinge, St. Steel AISI 316

Διαστάσεις / Dim (WxLxTh):

38x57x4

**34-0110**

Μεντεσές χυτός, Ανοξειδωτος AISI 316
 Door hinge, St. Steel AISI 316

Διαστάσεις / Dim (WxLxTh):
 38x73x4

**34-0111**

Μεντεσές χυτός, Ανοξειδωτος AISI 316
 Strap hinge, St. Steel AISI 316

Διαστάσεις / Dim (WxLxTh):
 27x160x4

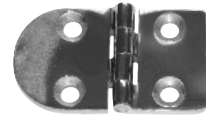
**34-0112**

Μεντεσές χυτός, Ανοξειδωτος AISI 316
 Door hinge, St. Steel AISI 316

Διαστάσεις / Dim (WxLxTh):
 40x69x4

**34-0113**

Μεντεσές χυτός, Ανοξειδωτος AISI 316
 Strap hinge, St. Steel AISI 316

Διαστάσεις / Dim (WxLxTh):
 27x104x4

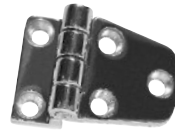
**34-0114**

Μεντεσές χυτός με γόνατο,
 Ανοξειδωτος AISI 316
 Offset hinge, St. Steel AISI 316

Διαστάσεις / Dim (WxLxTh):
 37x52x5

**34-0115**

Μεντεσές χυτός με γόνατο,
 Ανοξειδωτος AISI 316
 Offset hinge, St. Steel AISI 316

Διαστάσεις / Dim (WxLxTh):
 39x71x4

**34-0116**

Μεντεσές χυτός στρογγυλός,
 Ανοξειδωτος AISI 316
 Round hinge casted, St. Steel AISI 316

Διαστάσεις / Dim (WxLxTh):
 64x64x4

**34-0117**

Μεντεσές χυτός, στρογγυλός
 Ανοξειδωτος AISI 316
 Hinge casted, St. Steel AISI 316

Διαστάσεις / Dim (WxLxTh):
 81x64x4

**34-0120**

Μεντεσές πύρου χυτός με γόνατο,
 Ανοξειδωτος AISI 316
 Hatch hinge angle base, St. Steel AISI 316

Διαστάσεις / Dim (WxLxTh):
 52x53x7

**34-0121**

Μεντεσές πύρου χυτός ίσιος,
 Ανοξειδωτος AISI 316
 Hatch hinge standard, St. Steel AISI 316

Διαστάσεις / Dim (WxLxTh):
 52x53x6

**34-0122**

Μεντεσές B.T., Roca, Ανοξειδωτος AISI
 304
 Heavy duty hinge, Roca, St. Steel AISI 304

Διαστάσεις / Dim (WxLxTh):
 64x103x3

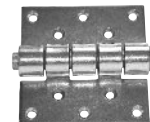
**34-0123**

Μεντεσές πύρου B.T., Razeto & Casareto,
 Ανοξειδωτος AISI 316
 Hinge removable pin, Razeto & Casareto,
 St. Steel AISI 316

Διαστάσεις / Dim (WxLxTh):
 100x100x5 - 14mm πύρος/pin



34-0124

Μεντεσές ρόμβου Β.Τ., SCM, Ανοξείδωτος AISI 316
Heavy duty hinge, SCM, St. Steel AISI 316

Διαστάσεις / Dim (WxLxTh):

40x82x2 52x101x3 61x121x3



34-0130

Μεντεσές πύρου Β.Τ., Roca, Ανοξείδωτος AISI 304
Heavy duty hinge, Roca, St. Steel AISI 304

Διαστάσεις / Dim (WxLxTh):

82x93x4 - 8mm πύρος/pin



34-0131

Μεντεσές πύρου Β.Τ., Roca, Ανοξείδωτος AISI 3046
Heavy duty hinge, Roca, St. Steel AISI 304

Διαστάσεις / Dim (WxLxTh):

82x185x4 - 8mm πύρος/pin



34-0132

Μεντεσές πύρου Β.Τ., Roca, Ανοξείδωτος AISI 304
Heavy duty hinge, Roca, St. Steel AISI 304

Διαστάσεις / Dim (WxLxTh):

69x190x4 - 8mm πύρος/pin

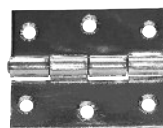

34-0133

Μεντεσές, Ανοξείδωτος AISI 304
Hinge, St. Steel AISI 304

Διαστάσεις / Dim (WxLxTh):

62x50x2



34-0134

Μεντεσές πύρου Β.Τ., Takigen, Ανοξείδωτος AISI 304
Heavy duty hinge, Takigen, St. Steel AISI 304

Διαστάσεις / Dim (WxLxTh):

107x140x4 - 12mm πύρος/pin

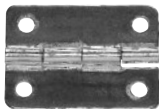

34-0150

Μεντεσές, Ανοξείδωτος AISI 304
Hinge, St. Steel AISI 304

Διαστάσεις / Dim (WxLxTh):

40x30x1

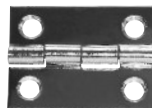

34-0151

Μεντεσές, Ανοξείδωτος AISI 316
Hinge, St. Steel AISI 316

Διαστάσεις / Dim (WxLxTh):

39x51x1,5

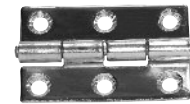

34-0152

Μεντεσές, Ανοξείδωτος AISI 304
Hinge, St. Steel AISI 304

Διαστάσεις / Dim (WxLxTh):

30x50x1,5



34-0140

Μεντεσές με 4 βίδες, M8x60, Olcese Ricci, Ανοξείδωτος AISI 316
Hinge with 4 welded screws, M8x60, Olcese Ricci, St. Steel AISI 316

Διαστάσεις / Dim (WxLxTh):

60x123x3



34-0141

Μεντεσές με 2 βίδες, M8x60, Olcese Ricci, Ανοξείδωτος AISI 316
Hinge with 2 welded screws, M8x60, Olcese Ricci, St. Steel AISI 316

Διαστάσεις / Dim (WxLxTh):

60x92x3



34-0142

Μεντεσές με 4 βίδες, M8x60, Olcese Ricci, Ανοξείδωτος AISI 316
Hinge with 4 welded screws, M8x60, Olcese Ricci, St. Steel AISI 316

Διαστάσεις / Dim (WxLxTh):

60x92x3



**34-0143**

Μεντεσές με 4 βίδες, M8x60,
 Olcese Ricci, Ανοξείδωτος AISI 316
 Hinge with 4 welded screws, M8x60,
 Olcese Ricci, St. Steel AISI 316

Διαστάσεις / Dim (WxLxTh):

60x92x3

**34-0144**

Μεντεσές με 4 βίδες, M8x50,
 Roca, Ανοξείδωτος AISI 316
 Hinge with 4 welded screws, M8x50,
 Roca, St. Steel AISI 316

Διαστάσεις / Dim (WxLxTh):

60x85x3 60x110x3 60x120x3 60x160x3

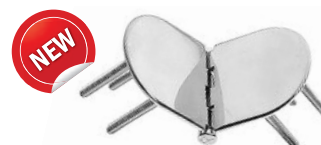
**34-0145**

Μεντεσές οβάλ τυφλός με ενσωματωμένες,
 βίδες, Roca, Ανοξείδωτος AISI 316
 Hinge stud welded reversed, Roca,
 St. Steel AISI 316

Διαστάσεις / Dim (WxLxTh):

130x60x6 160x60x3

**34-0201**

Μεντεσές, Roca, Ανοξείδωτος AISI 316
 Hinge, Roca, St. Steel AISI 316

Διαστάσεις / Dim (WxLxTh):

58x160x2

**34-0203**

Μεντεσές, Ανοξείδωτος AISI 316
 Hinge, St. Steel AISI 316

Διαστάσεις / Dim (WxLxTh):

70x60x2

**34-0204**

Μεντεσές, Roca, Ανοξείδωτος AISI 304
 Hinge, Roca, St. Steel AISI 304

Διαστάσεις / Dim (WxLxTh):

63x75x2 74x75x2

**34-0206**

Μεντεσές, Roca, Ανοξείδωτος AISI 304
 Hinge, Roca, St. Steel AISI 304

Διαστάσεις / Dim (WxLxTh):

75x150x2

**34-0208**

Μεντεσές, Roca, Ανοξείδωτος AISI 316
 Hinge, Roca, St. Steel AISI 316

Διαστάσεις / Dim (WxLxTh):

40x38x2

**34-0209**

Μεντεσές, Roca, Ανοξείδωτος AISI 304
 Butt hinge, Roca, St. Steel AISI 304

Διαστάσεις / Dim (WxLxTh):

30x30x1,5

**34-0210**

Μεντεσές, Ανοξείδωτος AISI 316
 Hinge, St. Steel AISI 316

Διαστάσεις / Dim (WxLxTh):

38x36x2

**34-0211**

Μεντεσές, Roca, Ανοξείδωτος AISI 316
 Hinge, Roca, St. Steel AISI 316

Διαστάσεις / Dim (WxLxTh):

40x48x2

**34-0212**

Μεντεσές, Roca, Ανοξείδωτος AISI 316
 Hinge, Roca, St. Steel AISI 316

Διαστάσεις / Dim (WxLxTh):

40x60x2





34-0213

Μεντεσές, Ανοξείδωτος AISI 304
Hinge, St. Steel AISI 304

Διαστάσεις / Dim (WxLxTh):
41x54x2



34-0214

Μεντεσές, Roca, Ανοξείδωτος AISI 304
Hinge, Roca, St. Steel AISI 304

Διαστάσεις / Dim (WxLxTh):
37x68x2



34-0154

Μεντεσές τετράγωνος, Ανοξείδωτος
Square hinge, St. Steel

Διαστάσεις / Dim:
50,9x50,6x2



34-0215

Μεντεσές χυτός, Ανοξείδωτος AISI 316
Hinge, St. Steel AISI 316

Διαστάσεις / Dim (WxLxTh):
114x45x3



34-0216

Μεντεσές, Roca, Ανοξείδωτος AISI 304
Hinge, Roca, St. Steel AISI 304

Διαστάσεις / Dim (WxLxTh):
48x30x1,5



34-0217

Μεντεσές, Roca, Ανοξείδωτος AISI 316
Hinge, Roca, St. Steel AISI 316

Διαστάσεις / Dim (WxLxTh):
40x75x2



34-0217-1

Μεντεσές, Ανοξείδωτος AISI 316
Hinge, St. Steel AISI 316

Διαστάσεις / Dim (WxLxTh):
40x75x2



34-0218

Μεντεσές, Roca, Ανοξείδωτος AISI 316
Hinge, Roca, St. Steel AISI 316

Διαστάσεις / Dim (WxLxTh):
40x78x2



34-0219

Μεντεσές, Ανοξείδωτος AISI 316
Hinge, St. Steel AISI 316

Διαστάσεις / Dim (WxLxTh):
45x69x1



34-0220

Μεντεσές, Olcese Ricci,
Ανοξείδωτος AISI 316
Hinge, Olcese Ricci, St. Steel AISI 316

Διαστάσεις / Dim (WxLxTh):
40x94x1,5 30x85x1,5



34-0221

Μεντεσές, Olcese Ricci,
Ανοξείδωτος AISI 316
Hinge, Olcese Ricci, St. Steel AISI 316

Διαστάσεις / Dim (WxLxTh):
20x78x1,5



34-0222

Μεντεσές, Ανοξείδωτος AISI 304
Hinge, St. Steel AISI 304

Διαστάσεις / Dim (WxLxTh):
40x74x2



**34-0223****34-0223-2**

Μεντεσές (& ανάποδος), Roca,
Ανοξείδωτος AISI 316
Hinge, Roca, (& reversed) St. Steel AISI 316

Διαστάσεις / Dim (WxLxTh):

40x75x2

**34-0224**

Μεντεσές, Ανοξείδωτος AISI 304
Hinge, St. Steel AISI 304

Διαστάσεις / Dim (WxLxTh):

40x74x2

**34-0225**

Μεντεσές, Ανοξείδωτος AISI 316
Hinge, St. Steel AISI 316

Διαστάσεις / Dim (WxLxTh):

38x73x2

**34-0226**

Μεντεσές, Roca, Ανοξείδωτος AISI 304
Hinge, Roca, St. Steel AISI 304

Διαστάσεις / Dim (WxLxTh):

40x30x1,5

**34-0227**

Μεντεσές, Roca, Ανοξείδωτος AISI 304
Hinge, Roca, St. Steel AISI 304

Διαστάσεις / Dim (WxLxTh):

58x37x2

**NEW****34-0255****34-0255-1**

Μεντεσές, μέσα τρύπες, (& ανάποδος)
Roca, Ανοξείδωτος AISI 316
Hinge, inside holes, (& reversed) Roca,
St. Steel AISI 316

Διαστάσεις / Dim:

40x180x2

**34-0256**

Μεντεσές με τρύπες στις άκρες, Roca,
Ανοξείδωτος AISI 304
Hinge with holes at both edges, Roca,
St. Steel AISI 304

Διαστάσεις / Dim:

40x180x2

**34-0228**

Μεντεσές, Ανοξείδωτος AISI 316
Hinge, St. Steel AISI 316

Διαστάσεις / Dim (WxLxTh):

45x150x2

**34-0229**

Μεντεσές, Ανοξείδωτος AISI 316
Hinge, St. Steel AISI 316

Διαστάσεις / Dim (WxLxTh):

39x140x2

**34-0229-1**

Μεντεσές, Roca, Ανοξείδωτος AISI 316
Hinge, Roca, St. Steel AISI 316

Διαστάσεις / Dim (WxLxTh):

39x138x2

**34-0230**

Μεντεσές, Ανοξείδωτος AISI 304
Hinge, St. Steel AISI 304

Διαστάσεις / Dim (WxLxTh):

45x110x2

**34-0231**

Μεντεσές, Ανοξείδωτος AISI 316
Hinge, St. Steel AISI 316

Διαστάσεις / Dim (WxLxTh):

41x76x2





34-0231-1

Μεντεσές, Roca, Ανοξείδωτος AISI 316
Hinge, Roca, St. Steel AISI 316

Διαστάσεις / Dim (WxLxTh):
41x76x2



34-0232

Μεντεσές, Ανοξείδωτος AISI 304
Hinge, St. Steel AISI 304

Διαστάσεις / Dim (WxLxTh):
27x105x2



34-0233

Μεντεσές, Roca, Ανοξείδωτος AISI 316
Hinge, Roca, St. Steel AISI 316

Διαστάσεις / Dim (WxLxTh):
40x67x2



34-0234

Μεντεσές, Ανοξείδωτος AISI 316
Hinge, St. Steel AISI 316

Διαστάσεις / Dim (WxLxTh):
38x71x2



34-0235

Μεντεσές, Ανοξείδωτος AISI 304
Hinge, St. Steel AISI 304

Διαστάσεις / Dim (WxLxTh):
40x62x2



34-0236

Μεντεσές, Ανοξείδωτος AISI 316
Hinge, St. Steel AISI 316

Διαστάσεις / Dim (WxLxTh):
37x56x2



34-0238

Μεντεσές, Roca, Ανοξείδωτος AISI 316
Hinge, Roca, St. Steel AISI 316

Διαστάσεις / Dim (WxLxTh):
40x60x2



34-0240

Μεντεσές, Ανοξείδωτος AISI 316
Hinge, St. Steel AISI 316

Διαστάσεις / Dim (WxLxTh):
38x62x2



34-0241

Μεντεσές, Ανοξείδωτος AISI 316
Hinge, St. Steel AISI 316

Διαστάσεις / Dim (WxLxTh):
39x86x2



34-0244

Μεντεσές, Ανοξείδωτος AISI 316
Hinge, St. Steel AISI 316

Διαστάσεις / Dim (WxLxTh):
39x106x2



34-0245

Μεντεσές, Roca, Ανοξείδωτος AISI 316
Hinge, Roca, St. Steel AISI 316

Διαστάσεις / Dim (WxLxTh):
40x100x2



34-0246

Μεντεσές, Roca, Ανοξείδωτος AISI 316
Hinge, Roca, St. Steel AISI 316

Διαστάσεις / Dim (WxLxTh):
40x127x2



**34-0247**

Μεντεσές, Roca, Ανοξειδωτος AISI 316
 Hinge, Roca, St. Steel AISI 316

Διαστάσεις / Dim (WxLxTh):
 39x107x2

**34-0248**

Μεντεσές, Roca, Ανοξειδωτος AISI 316
 Hinge, Roca, St. Steel AISI 316

Διαστάσεις / Dim (WxLxTh):
 40x98x2,5

**34-0249**

Μεντεσές, Jeakel, Ανοξειδωτος AISI 316
 Hinge, Jeakel, St. Steel AISI 316

Διαστάσεις / Dim (WxLxTh):
 38x127x2

**34-0250**

Μεντεσές, Roca, Ανοξειδωτος AISI 316
 Hinge, Roca, St. Steel AISI 316

Διαστάσεις / Dim (WxLxTh):
 40x96x2

**34-0251**

Μεντεσές, Ανοξειδωτος AISI 316
 Hinge, St. Steel AISI 316

Διαστάσεις / Dim (WxLxTh):
 41x124x2

**34-0251-1**

Μεντεσές, Roca, Ανοξειδωτος AISI 316
 Hinge, Roca, St. Steel AISI 316

Διαστάσεις / Dim (WxLxTh):
 40x129x2

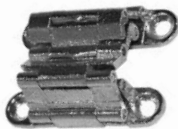
**34-0850**

Μεντεσές ραπτομηχανής,
 Olcese Ricci, Nickel plated
 Hinge invisible, Olcese Ricci, Nickel plated

Διαστάσεις / Dim:
 28x39 45x41 45x52

**34-0252**

Μεντεσές, Ανοξειδωτος AISI 316
 Hinge, St. Steel AISI 316

Διαστάσεις / Dim (WxLxTh):
 30x77x1,5 30x81x1,5

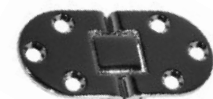
**34-0257**

Μεντεσές ραπτομηχανής,
 Roca, Ανοξειδωτος
 Hinge, Roca, St. Steel

Διαστάσεις / Dim:
 38x76x2

**34-0254**

Μεντεσές, Roca, Ανοξειδωτος AISI 316
 Hinge, Roca, St. Steel AISI 316

Διαστάσεις / Dim (WxLxTh):
 40x70x2 40x74x2



ARCH

34-0303

Μεντεσές πράσινο, Arch,
 Ανοξειδωτος AISI 304
 Hinge green, Arch, St. Steel AISI 304

Διαστάσεις / Dim (LxWxTh):

No 38	38x32x1,2
No 51	51x35x1,0
No 64	64x40x1,0
No 76	76x50x1,5
No 89	89x56x1,2
No 102	100x75x1,5
No 127	127x82x1,5



34-0306

Μεντεσές, Mavi Mare,
Ανοξείδωτος AISI 316
Hinge, Mavi Mare, St. Steel AISI 316

Διαστάσεις / Dim (WxL):
30x146



34-0308

Μεντεσές, Mavi Mare,
Ανοξείδωτος AISI 316
Hinge, Mavi Mare, St. Steel AISI 316

Διαστάσεις / Dim (WxL):
28x104



34-0308-1

Μεντεσές, Ανοξείδωτος
Hinge, St. Steel

Διαστάσεις / Dim (LxWxTh):
140x25x2



34-0311

Μεντεσές ανάποδος, Roca,
Ανοξείδωτος AISI 304
Hinge, Roca, St. Steel AISI 304

Διαστάσεις / Dim (WxLxTh):
30x42x1,5



34-0312

Μεντεσές ανάποδος, Roca,
Ανοξείδωτος AISI 316
Hinge reversed, Roca, St. Steel AISI 316

Διαστάσεις / Dim (WxLxTh):
30x48x1,5



34-0312-1

Μεντεσές ανάποδος, Roca,
Ανοξείδωτος AISI 316
Hinge, Roca, St. Steel AISI 316

Διαστάσεις / Dim:
40x74x2



34-0313

Μεντεσές, Roca, Ανοξείδωτος AISI 304
Hinge, Roca, St. Steel AISI 304

Διαστάσεις / Dim (WxLxTh):
40x129x2



34-0314

Μεντεσές ανάποδος, Roca,
Ανοξείδωτος AISI 304
Hinge reversed, Roca, St. Steel AISI 304

Διαστάσεις / Dim (WxLxTh):
39x108x2



34-0315

Μεντεσές ανάποδος, Roca,
Ανοξείδωτος AISI 316
Hinge reversed, Roca, St. Steel AISI 316

Διαστάσεις / Dim (WxLxTh):
38x68x2



34-0316

Μεντεσές ανάποδος, Roca,
Ανοξείδωτος AISI 304
Hinge reversed, Roca,
St. Steel AISI 304

Διαστάσεις / Dim (WxLxTh):
40x127x2



34-0317

Μεντεσές ανάποδος, Roca,
Ανοξείδωτος AISI 316
Hinge reversed, Roca,
St. Steel AISI 316

Διαστάσεις / Dim (WxLxTh):
40x92x2



34-0318

Μεντεσές ανάποδος, Roca,
Ανοξείδωτος AISI 304
Hinge reversed, Roca, St. Steel AISI 304

Διαστάσεις / Dim (WxLxTh):
37x68x2



**34-0319**

Μεντεσές ανάποδος, Roca,
Ανοξείδωτος AISI 316
Hinge reversed, Roca, St. Steel AISI 316

Διαστάσεις / Dim (WxLxTh):

37x60x2

**34-0320**

Μεντεσές ανάποδος, Roca,
Ανοξείδωτος AISI 304
Hinge reversed, Roca, St. Steel AISI 304

Διαστάσεις / Dim (WxLxTh):

40x70x2

**34-0321**

Μεντεσές με γόνατο,
Ανοξείδωτος AISI 304
Hinge, St. Steel AISI 304

Διαστάσεις / Dim (WxLxTh):

40x55x2 / h12

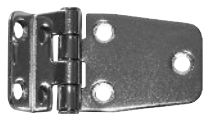
**34-0322**

Μεντεσές με γόνατο, Roca,
Ανοξείδωτος AISI 304
Hinge, Roca, St. Steel AISI 304

Διαστάσεις / Dim (WxLxTh):

37x65x2 / h10 37x65x2 / h15
37x65x2 / h12 37x65x2 / h20

**34-0323**

Μεντεσές με γόνατο, Roca,
Ανοξείδωτος AISI 304
Hinge, Roca, St. Steel AISI 304

Διαστάσεις / Dim (WxLxTh):

37x40x2 / h10 37x40x2 / h15
37x40x2 / h12 37x40x2 / h20

**34-0324**

Μεντεσές με διπλό γόνατο, Roca,
Ανοξείδωτος AISI 304
Hinge, Roca, St. Steel AISI 304

Διαστάσεις / Dim (WxLxTh):

37x41x2 / h10

**34-0325**

Μεντεσές με διπλό γόνατο, Roca,
Ανοξείδωτος AISI 304
Hinge, Roca, St. Steel AISI 304

Διαστάσεις / Dim (WxLxTh):

40x45x2 / h15

**34-0326**

Μεντεσές, Roca, Ανοξείδωτος AISI 304
Hinge, Roca, St. Steel AISI 304

Διαστάσεις / Dim (WxLxTh):

40x130x2,5 / h24
40x130x2,5 / h34

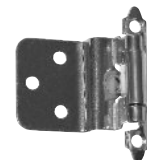
**34-0327**

Μεντεσές με διπλό γόνατο, Roca,
Ανοξείδωτος AISI 304
Hinge, Roca, St. Steel AISI 304

Διαστάσεις / Dim (WxLxTh):

41x58x1,5 h10 / h12 / h15 / h20

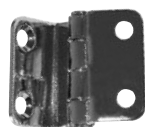
**34-0328**

Μεντεσές με γόνατο,
Ανοξείδωτος AISI 304
Hinge, St. Steel AISI 304

Διαστάσεις / Dim (WxLxTh):

38x56x2 h12 40x50x2 h15

**34-0801**

Μεντεσές πορταδέλα,
Ανοξείδωτος AISI 316
Take apart hinge, St. Steel AISI 316

Διαστάσεις / Dim (LxWxTh):

39x95x5 - 8mm πύρος / pin

**34-0802**

Μεντεσές πορταδέλα-γόνατο, Roca,
Ανοξείδωτος AISI 304
Hinge, Roca, St. Steel AISI 304

Διαστάσεις / Dim (LxWxTh):

41x37x2 - 58mm πύρος / pin



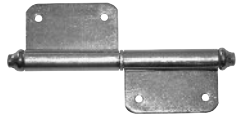

34-0803

Μεντεσές πορταδέλα,
Ανοξείδωτος AISI 304
Hinge, St. Steel AISI 304

Διαστάσεις / Dim (LxWxTh):

70x40x2	120x68x2
100x65x2	140x75x2,5



34-0804

Μεντεσές πορταδέλα-γόνατο,
Ανοξείδωτος AISI 316
Hinge, St. Steel AISI 316

Διαστάσεις / Dim (LxWxTh):

74x60x1,5

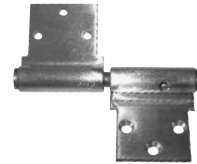

34-0805

Μεντεσές πορταδέλα Β.Τ.,
Ανοξείδωτος AISI 304
Heavy duty hinge, St. Steel AISI 304

Διαστάσεις / Dim (WxLxTh):

130x65x4

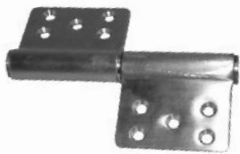

34-0806

Μεντεσές πορταδέλα,
Ανοξείδωτος AISI 304
Hinge, St. Steel AISI 304

Διαστάσεις / Dim (WxLxTh):

5" x 5" x 3

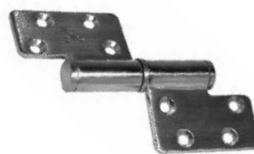

34-0824

Μεντεσές πορταδέλα, Roca,
Ανοξείδωτος AISI 316
Hinge, Roca, St. Steel AISI 316

Διαστάσεις / Dim:

L120

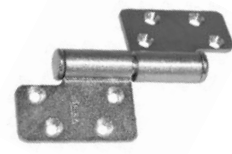

34-0824-1

Μεντεσές πορταδέλα, Roca, Γαλβανιζέ
Hinge, Roca, Galvanized

Διαστάσεις / Dim:

L120



34-0828

Μεντεσές πορταδέλα πύρος,
Razeto & Casareto, Ανοξείδωτος
Hinge, Razeto & Casareto, St. Steel

Διαστάσεις / Dim (WxLxTh):

110x95x3

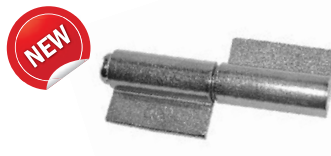

34-0829

Μεντεσές πύρος κολλητός, Ανοξείδωτος
Hinge welding edges, St. Steel

Διαστάσεις / Dim:

1. L110	Ø10 / 18-4mm
2. L120	Ø12 / 22-5mm

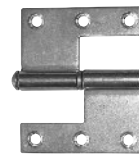

34-0808

Μεντεσές γαλλικός Razeto & Casareto,
Ανοξείδωτος AISI 316
Hinge, Razeto & Casareto, St. Steel AISI 316

Διαστάσεις / Dim (LxWxTh):

50x60x2



34-0809

Μεντεσές γαλλικός, Takigen,
Ανοξείδωτος AISI 316
Slip joint hinge, Takigen, St. Steel AISI 316

Διαστάσεις / Dim (WxLxTh):

32x50x1,5	35x60x2	37x75x2
-----------	---------	---------

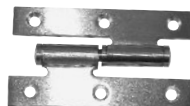

34-0810

Μεντεσές γαλλικός,
Ανοξείδωτος AISI 304
Hinge, St. Steel AISI 304

Διαστάσεις / Dim (LxWxTh):

4" x 2,5" x 2,5	4" x 3,5" x 3,	140x68x3,
-----------------	----------------	-----------

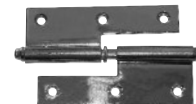

34-0811

Μεντεσές γαλλικός, Ανοξείδωτος AISI 304
Hinge, St. Steel AISI 304

Διαστάσεις / Dim (LxWxTh):

70x40x2	120x75x2
100x53x2	140x95x2,5

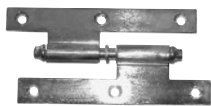
**34-0812**

Μεντεσές γαλλικός στενός,
Ανοξείδωτος AISI 304
Hinge, St. Steel AISI 304

Διαστάσεις / Dim (WxLxTh):

70x40x2	100x65x2	140x65x2
---------	----------	----------

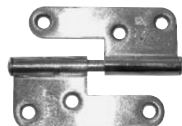
**34-0813**

Μεντεσές γαλλικός, Roca,
Ανοξείδωτος AISI 316
Lift off hinge, Roca, St. Steel AISI 316

Διαστάσεις / Dim (WxLxTh):

85x74x2,5	82x98x2,5	98x110x3
-----------	-----------	----------

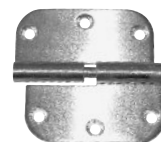
**34-0814**

Μεντεσές γαλλικός, Ανοξείδωτος AISI 316
Hinge, St. Steel AISI 316

Διαστάσεις / Dim (WxLxTh):

3" x 3" x 2

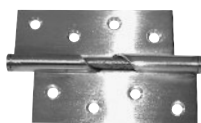
**34-0823**

Μεντεσές γαλλικός (raised),
Ανοξείδωτος AISI 304
Hinge, St. Steel AISI 304

Διαστάσεις / Dim (WxLxTh):

4" x 3" x 2	4" x 3" x 2,5	4" x 3 x 3
-------------	---------------	------------

**34-0827**

Μεντεσές γαλλικός, πύρος Ø13,
Razeto & Casareto, Ανοξείδωτος
Hinge, Razeto & Casareto, St. Steel

Διαστάσεις / Dim (WxLxTh):

110x75x2	110x90x2
----------	----------

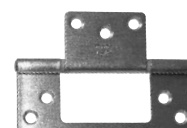
**34-0815**

Μεντεσές χωνευτός, Ανοξείδωτος AISI 304
Hinge, St. Steel AISI 304

Διαστάσεις / Dim (LxW):

64x24	89x37
76x33	102x41

**34-0816**

Πύρος κολλητός με αυτιά,
Ανοξείδωτος AISI 304
Welded hinge, St. Steel AISI 304

Διαστάσεις / Dim (WxTh):

8x6	10x6	12x8	14x10
-----	------	------	-------

**34-0817**

Πύρος κολλητός, Ανοξείδωτος AISI 304
Welded round hinge pin, St. Steel AISI 304

Διαστάσεις / Dim (WxTh):

12x6	20x10
16x8	25x12

**34-0136**

Μεντεσές Β.Τ., Ανοξείδωτος
Heavy duty hinge, St. Steel

Διαστάσεις / Dim (WxLxTh):

95x120x3	πύρος / pin: 8mm
----------	------------------

**34-0818**

Μεντεσές Β.Τ., χωρίς ροδέλες,
Ανοξείδωτος AISI 304
Heavy duty hinge, St. Steel AISI 304

Διαστάσεις / Dim (WxLxTh):

4" x 4" x 2

**34-0819**

Μεντεσές Β.Τ. με 2 ΒΒ μεταλλικά,
Ανοξείδωτος AISI 304
Heavy duty hinge, St. Steel AISI 304

Διαστάσεις / Dim (WxLxTh):

3" x 3" x 2	3,5" x 3,5" x 2,5	4" x 3,5" x 2,5
-------------	-------------------	-----------------

**34-0820**

Μεντεσές Β.Τ. με 4 ΒΒ μεταλλικά,
Ανοξείδωτος AISI 304
Heavy duty hinge, St. Steel AISI 304

Διαστάσεις / Dim (WxLxTh):

4" x 3" x 3	5" x 3" x 3	5" x 5" x 3,5
4" x 4" x 2,5	5" x 3,5" x 3	6" x 4" x 3
4" x 4" x 3	5" x 4" x 3	6" x 5" x 3
4,5" x 4" x 4	5" x 5" x 3	

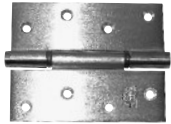

34-0821

Μεντεσές Β.Τ. με 2 ροδέλες πλαστικές, Ανοξείδωτος AISI 304
Heavy duty hinge with 2 plastic washers, St. Steel AISI 304

Διαστάσεις / Dim (WxLxTh):
102x82x2

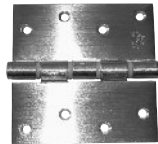

34-0822

Μεντεσές Β.Τ. με 4 ροδέλες πλαστικές, Ανοξείδωτος AISI 304
Heavy duty hinge with 4 plastic washers, St. Steel AISI 304

Διαστάσεις / Dim (WxLxTh):
102x102x2 4"x4"x2 4"x4"x3

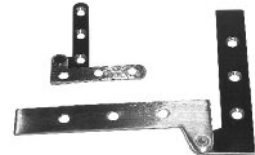

34-0826

Μεντεσές Pivot, Ανοξείδωτος
Hinge Pivot, St. Steel

Διαστάσεις / Dim:
20x50x2 32x100x2



34-0830

Μεντεσές, Jaekel, μαύρο ή άσπρο πλαστικό
Plastic hinge, Jaekel, in black or white

Διαστάσεις / Dim (WxLxTh):
50x60x8

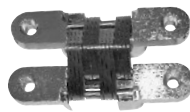

34-0834

Μεντεσές χωνευτός, Zinc / Ανοξείδωτος AISI 304
Hinge, Zinc / St. Steel AISI 304

Διαστάσεις / Dim:

No 1 L25,4	No 5 L69,8
No 2 L42,9	No 6 L95,2
No 3 L44,5	No 8 L117,5
No 4 L60,3	No 9 L139,7



34-0831

Μεντεσές aller-retour, Satin, Ανοξείδωτος AISI 304
Aller-retour hinge, Satin, St. Steel AISI 304

Διαστάσεις / Dim:
4" 5" 6"



34-0832

Μεντεσές aller-retour, mirror polished Ανοξείδωτος AISI 304
Aller-retour hinge, mirror polished, St. Steel AISI 316

Διαστάσεις / Dim:
4" 5" 6"

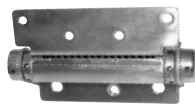

34-0833

Μεντεσές Aller, Jaekel, Ανοξείδωτος AISI 304
Aller-retour hinge, Jaekel, St. Steel AISI 304

Διαστάσεις / Dim (WxLxTh):
50x60x8



34-0835

Μεντεσές, Jaekel, Ανοξείδωτος AISI 304
Hinge, Jaekel, St. Steel AISI 304

L60 L70 L80



34-0836

Μεντεσές κουζίνας, Jaekel, Ανοξείδωτος AISI 304
Hinge, Jaekel, St. Steel AISI 304

Διαστάσεις / Dim (WxL):
59x94/h9 59x94/h14 59x94/h19 flat



34-0838

Μεντεσές τραπέζιού, Razeto & Casareto, Ανοξείδωτος AISI 316
Spring hinge for folding table, Razeto & Casareto, St. Steel AISI 316

Διαστάσεις / Dim (WxLxTh):
68x90x2

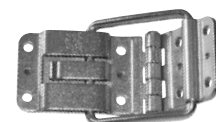

34-0839

Μεντεσές τραπέζιού, Jaekel, Ανοξείδωτος AISI 316
Spring hinge for folding table, Jaekel, St. Steel AISI 316

Διαστάσεις / Dim (WxLxTh):
68x90x2



**34-0840**

Μεντεσές τραπεζιού, Roca,
Ανοξείδωτος AISI 304
Folding bracket, Roca,
St. Steel AISI 304

Διαστάσεις / Dim:
300x160x20

**34-0841**

Μεντεσές τραπεζιού,
Ανοξείδωτος AISI 316
Folding bracket,
St. Steel AISI 316

Διαστάσεις / Dim:
300x160x20

**34-0845**

Μεντεσές, γωνία σπαστή, Lamp,
Ανοξείδωτος AISI 304
Hinge, bracket, Lamp,
St. Steel AISI 304

LAMP
by Roca

**34-0844**

Πτυσσόμενος μεντεσές τραπεζιού B.T.,
Roca, Ανοξείδωτος AISI 316
Heavy duty folding bracket, Roca,
St. Steel AISI 316

Εξαιρετικό για εφαρμογές με μεγάλο βάρος.
Μέγιστο στατικό βάρος:
Στο κοντό άκρο: 1.800kg
Στο μακρύ άκρο: 800kg
Excellent for heavy jump seat applications.
Maximum static weight:
Short ext: 1.800kg
Long ext: 800kg

Διαστάσεις / Dim:
312x174x35

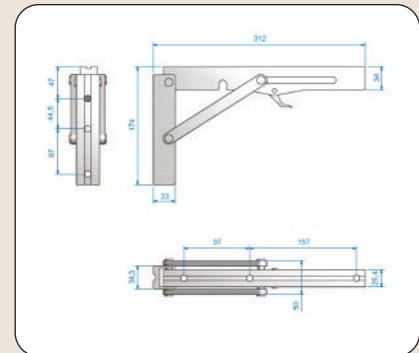
**34-0842**

Μεντεσές ψυγείου, Takigen, Zinc
Freezer hinge, Takigen, Zinc

Διαστάσεις / Dim (WxL):
250x140 - flat / h29 / h35 / h48

TAKIGEN

**34-0258**

Μεντεσές κουपाστής ξύλου,
Ανοξείδωτος AISI 316
Hinge, Roca, St. Steel AISI 316

**34-0259**

Κλείστρο μεντεσέ κουπαστής ξύλου,
Ανοξείδωτο AISI 316
Latch, St. Steel AISI 316

**34-0330**

Καπάκια για μεντεσέδες, Roca,
Ανοξείδωτα AISI 316
Hinge caps, Roca, St. Steel AISI 316

Διαστάσεις / Dim:

1. 33,25x 41,50
2. 66,25x 41,50
3. 34,25x 41,50
4. 18,25x 41,50
5. 15,25x 41,50

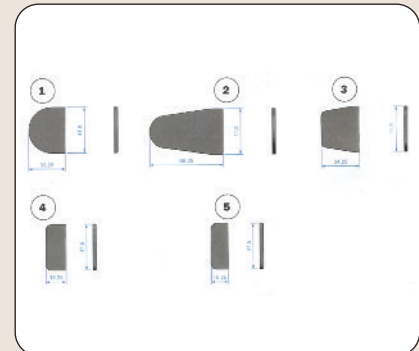

Μάσκουλα - Σπανιολέτες Wooden door hinges - Espagnolettes

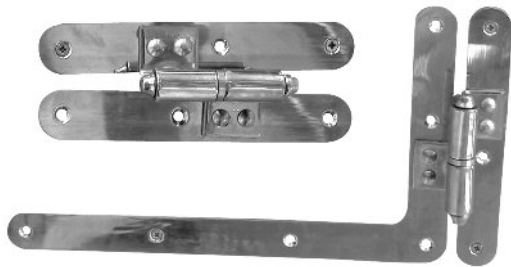

34-1101

Μάσκουλο Ανοξείδωτο AISI 316 με λαμπά από 0 ως 200mm
Wooden door hinge, St. Steel AISI 316



35-4110

Σπανιολέτα, Roca 100, ιδανική για όλες τις δίφυλλες πόρτες με άνοιγμα 2.450mm, Ανοξείδωτη AISI 316
Espagnolette, Roca 100, for all kind of double doors. Height of door opening, 2.450 mm, St. Steel AISI 316



35-4111

Άξονας για σπανιολέτα, διάμετρος πύρου 12mm, Roca 100, Ανοξείδωτος AISI 316
Rod for espagnolette, diameter of rod 12 mm, Roca 100, St. Steel AISI 316



Μεντεσές μέτρου Continuous hinges

34-1001

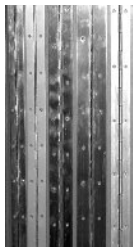

Μεντεσές μέτρου με τρύπες, Ανοξείδωτος
Continuous hinge
with holes, St. Steel
L=1800, Th=0,70, Pin=1,75

Διαστάσεις / Dim:

W25 W32 W38 W50

34-1002

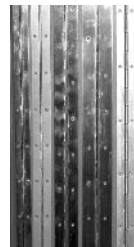

Μεντεσές μέτρου με τρύπες, Ανοξείδωτος
Continuous hinge
with holes, St. Steel
L=2000, Th=1,25, Pin=2,5

Διαστάσεις / Dim:

W30 W40 W50

34-1003



Μεντεσές μέτρου χωρίς τρύπες, Ανοξείδωτος,
Continuous hinge without holes, St. Steel
L=2000, Th=0,80, Pin=4,0

Διαστάσεις / Dim:

W30 W40 W50

34-1004



Μεντεσές μέτρου χωρίς τρύπες, Ανοξείδωτος
Continuous hinge without holes, St. Steel
L=2000, Th=2,00,- Pin=6,0

Διαστάσεις / Dim:

W30 W40 W50 W60

NEW

34-1010

Μεντεσές για Flaps,
Ανοξείδωτος AISI 316
Hinge for flaps, St. Steel AISI 316

Διαστάσεις / Dim (WxLxTh):

80x1.000x2
115x500x3
115x1.000x3

NEW

34-1020

Μεντεσές για Flaps, γυάλισμα καθρέπτη,
Ανοξείδωτος AISI 316
Hinge for flaps, mirror polished,
St. Steel AISI 316

Διαστάσεις / Dim (WxLxTh):

50x1.000x1,5 Πύρος/Pin 3mm
52x1.000x2 Πύρος/Pin 6mm

Μεντεσέδες για κρύσταλλο Shower hinges



33-0801

Μεντεσές για κρύσταλλο 10mm, 180°, Ανοξείδωτος AISI 304
Shower hinge for glass 10mm, 180°, St. Steel AISI 304



33-0802

Μεντεσές για κρύσταλλο 10mm, σταθερό σημείο, εσωτερικός, Ανοξείδωτος AISI 304
Shower hinge for glass 10mm, St. Steel AISI 304



33-0803

Μεντεσές για κρύσταλλο 10mm, διπλός, εξωτερικός, Ανοξείδωτος AISI 304
Shower hinge for glass 10mm, double, St. Steel AISI 304



33-0804

Μεντεσές για κρύσταλλο 10mm, από σταθερό σημείο, εξωτερικός, Ανοξείδωτος AISI 304
Shower hinge for glass 10mm, St. Steel AISI 304



33-0805

Μεντεσές για κρύσταλλο 10mm, διπλός, ασύμμετρος, Ανοξείδωτος AISI 304
Shower hinge for glass 10mm, double, asymmetric, St. Steel AISI 304



33-0806

Γωνία 90° σύνδεσης κρυστάλλου, Ανοξείδωτη AISI 304
Glass clip 90°, St. Steel AISI 304



33-0807

Γωνία 90° σύνδεσης κρυστάλλου σε τοίχο, Ανοξείδωτη AISI 304
Glass clip 90° for wall, St. Steel AISI 304



33-0808

Γωνία 90° σύνδεσης κρυστάλλου κοντή, Ανοξείδωτη AISI 304
Glass clip 90°, St. Steel AISI 304



33-0809

Μεντεσές για κρύσταλλο 10mm, για πόρτα, Ανοξείδωτος AISI 316
Shower hinge for glass 10mm, St. Steel AISI 316
Finish: Satin / Mirror polished

**33-0810**

Μεντεσές, από κρύσταλλο 10mm
σε κρύσταλλο 10mm,
Ανοξείδωτος AISI 316
Shower hinge for glass 10mm,
St. Steel AISI 316
Finish: Satin / Mirror polished

**33-0811**

Μεντεσές για κρύσταλλο 10mm,
για πόρτα, Β.Τ., Ανοξείδωτος AISI 316
Heavy duty shower hinge for glass 10mm,
St. Steel AISI 316
Finish: Satin / Mirror polished

**35-4001**

Βάση κρυστάλλου φρεζάτο για spider,
Ανοξείδωτη AISI 304
Routel countersank for spider,
St. Steel AISI 304

**35-4002**

Βάση κρυστάλλου για spider επίπεδο,
Ανοξείδωτη AISI 304
Routel flat for spider,
St. Steel AISI 304

Σύστημα ανάκλισης γυάλινης πόρτας Patch fittings



33-0391

Στήριγμα PF-001 για Geze ή Speedy,
Ανοξείδωτο AISI 304
Patch fitting PF-001, Gese or Speedy,
St. Steel AISI 304



33-0392

Στήριγμα PF-002 για Geze ή Speedy,
Ανοξείδωτο AISI 304
Patch fitting PF-002, Gese or Speedy,
St. Steel AISI 304



33-0393

Στήριγμα PF-003 για Geze ή Speedy,
Ανοξείδωτο AISI 304
Patch fitting PF-003, Gese or Speedy,
St. Steel AISI 304



33-0394

Στήριγμα PF-004 για Geze ή Speedy,
Ανοξείδωτο AISI 304
Patch fitting PF-004, Gese or Speedy,
St. Steel AISI 304



33-0395

Στήριγμα PF-005 για Geze ή Speedy,
Ανοξείδωτο AISI 304
Patch fitting PF-005, Gese or Speedy,
St. Steel AISI 304

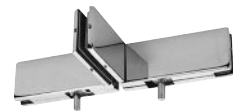

33-0396

Στήριγμα PF-006 για Geze ή Speedy,
Ανοξείδωτο AISI 304
Patch fitting PF-006, Gese or Speedy,
St. Steel AISI 304



33-3231

Dust proof strike DS004SS, St. Steel



33-3231-1

Dust proof strike DS003SS, St. Steel

06

Κομπάσα

Hatch stays

**33-1401**

Κομπάσο, Olcese Ricci, Ανοξείδωτο
Hatch stay, Olcese Ricci, St. Steel

Διαστάσεις / Dim:

L215 L275 L320

**33-1402**

Κομπάσο με θέσεις, Olcese Ricci, Ανοξείδωτο
Hatch stay, Olcese Ricci, St. Steel

Διαστάσεις / Dim:

L190 L260

**33-1403**

Κομπάσο τόξο, Olcese Ricci, Ανοξείδωτο
Curved hatch stay, Olcese Ricci, St. Steel

Διαστάσεις / Dim:

L220 L270

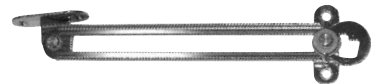
**33-1404**

Κομπάσο αυτόματο, Takigen, Ανοξείδωτο
Automatic hatch stay, Takigen, St. Steel

Διαστάσεις / Dim:

L165 L210 L280

**33-1405**

Κομπάσο, Razeto & Casareto, Chrome brass plated
Hatch stay, Razeto & Casareto, Chrome brass plated

Διαστάσεις / Dim:

L38x44 L44x57 L55x65

**33-1440**

Κομπάσο, Razeto & Casareto, Ανοξείδωτο
Hatch stay, Razeto & Casareto, St. Steel

Διαστάσεις (κλειστό-ανοιχτό) / Dim (closed-open):

L350-570





33-1406

Κομπάσο μπίλιας, Olcese Ricci, Ανοξείδωτο
Hatch stay, Olcese Ricci, St. Steel

Διαστάσεις / Dim:

L150 L200 L250 L300



33-1407

Κομπάσο ελατήριο, Ανοξείδωτο
Hatch spring holder, St. Steel

Διαστάσεις / Dim:

L230 L290



33-1450

Κομπάσο αερίου, Pressmair, Ανοξείδωτο AISI 316
Gas spring, Pressmair, St. Steel AISI 316



Διαστάσεις / Dim:

Σώμα Body	Άξονας Axle	Μήκος Length	Δύναμη Power
19	8	60	F500N
19	8	80	F500N
19	8	80	F800N
19	8	120	F800N
19	8	160	F800N
19	8	180	F800N
19	8	200	F800N
19	8	220	F800N
19	8	250	F800N

33-1451

Κομπάσο αερίου, Pressmair, Ανοξείδωτο AISI 316
Gas spring, Pressmair, St. Steel AISI 316

Διαστάσεις / Dim:

Σώμα Body	Άξονας Axle	Μήκος Length	Δύναμη Power
25	10	100	F800N
25	10	120	F800N
25	10	140	F800N
25	10	160	F800N
25	10	180	F800N
25	10	200	F800N
25	10	220	F800N
25	10	250	F800N
25	10	280	F800N
25	10	300	F1000N



33-1410

Κομπάσο μπουκάλα, Olcese Ricci, ρυθμιζόμενο, Ανοξείδωτο
Hatch stay adjustable, Olcese Ricci, St. Steel

Διαστάσεις (κλειστό-ανοιχτό) / Dim (closed-open):

L200-250 L300-560 L400-720



33-1412

Κομπάσο μπουκάλα, ρυθμιζόμενο,
Chrome brass plated
Hatch stay adjustable, Chrome brass plated

Διαστάσεις (κλειστό-ανοιχτό) / Dim (closed-open):

L270-430

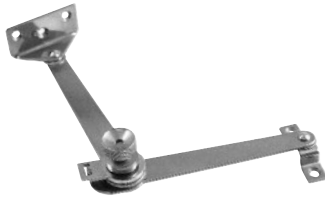

**33-1421**

Κομπάσο σπαστό,
Olcese Ricci, Ανοξείδωτο
Hatch stay with locking system,
Olcese Ricci, St. Steel

**Διαστάσεις (κλειστό-ανοιχτό) /
Dim (closed-open):**

L150-250

**33-1422**

Κομπάσο σπαστό, Ανοξείδωτο
Hatch stay, St. Steel

**Διαστάσεις (κλειστό-ανοιχτό) /
Dim (closed-open):**

L240-300

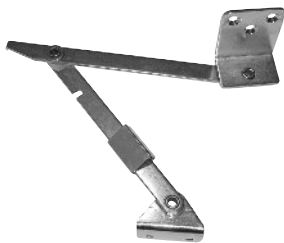
**33-1423**

Κομπάσο σπαστό B.T.,
Olcese Ricci, Ανοξείδωτο
Heavy duty hatch stay with
catch for open position,
Olcese Ricci, St. Steel

**Διαστάσεις (κλειστό-ανοιχτό) /
Dim (closed-open):**

L280-450

**33-1424**

Κομπάσο σπαστό,
Olcese Ricci, Ανοξείδωτο
Folding hatch stay,
Olcese Ricci, St. Steel

**Διαστάσεις (κλειστό-ανοιχτό) /
Dim (closed-open):**

L140-220

**33-1425**

Κομπάσο σπαστό,
Olcese Ricci, Ανοξείδωτο
Folding hatch stay,
Olcese Ricci, St. Steel

**Διαστάσεις (κλειστό-ανοιχτό) /
Dim (closed-open):**

L130-230

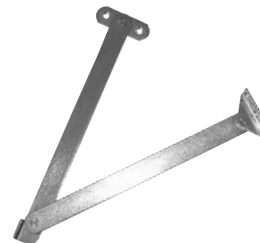
**33-1426**

Κομπάσο σπαστό,
Olcese Ricci, Ανοξείδωτο
Folding hatch stay,
Olcese Ricci, St. Steel

**Διαστάσεις (κλειστό-ανοιχτό) /
Dim (closed-open):**

L230-450

**33-1430**

Κομπάσο ελατήριο, Jaekel, Ανοξείδωτο
Hatch spring holder, Jaekel, St. Steel

Διαστάσεις / Dim:

L222 L335 L380

**33-1431**

Κομπάσο 2 θέσεων, Jaekel, Ανοξείδωτο
Twin stop hatch stay, Jaekel, St. Steel

Διαστάσεις (κλειστό-ανοιχτό) / Dim (closed-open):

L170-260 L220-330



33-1432

Κομπάσο σωληνωτό, Southco, Αλουμίνιο, λευκό-γκρι
Hatch stay, Southco, Aluminium, white-grey

Διαστάσεις / Dim:
L330 L470



33-1441

Κομπάσο με θέσεις, Ανοξείδωτο
Hatch stay, St. Steel

Διαστάσεις / Dim:
L260



33-1449

Αμορτισέρ αερίου, Olcese Ricci, Ανοξείδωτο AISI 316
Gas spring, Olcese Ricci, St. Steel AISI 316



Διαστάσεις / Dim (Ø - L / Strength):

- Ø15 - L250 / 5kg
- Ø15 - L250 / 10kg
- Ø15 - L250 / 18kg
- Ø19 - L355 / 12kg
- Ø19 - L355 / 18kg
- Ø19 - L355 / 30kg
- Ø19 - L500 / 14kg
- Ø19 - L500 / 20kg
- Ø19 - L500 / 30kg
- Ø19 - L500 / 40kg
- Ø19 - L600 / 20kg
- Ø19 - L600 / 30kg
- Ø25 - L700 / 25kg



33-1434

Κομπάσο Rakego, Roca, Αλουμίνιο (AA6063)
Folding bracket Rakego, Roca, Aluminium (AA6063)



Διαστάσεις / Dim (Ø - L / Strength):

- Ø20 - L150 / 30kg
- Ø20 - L247 / 30kg
- Ø20 - L392 / 30kg
- Ø20 - L544 / 30kg
- Ø25 - 161 / 35kg
- Ø25 - 252 / 55kg
- Ø25 - 402 / 60kg
- Ø25 - 549 / 80kg



33-1435

Κομπάσο Rakego, Roca, Μαύρο, Αλουμίνιο (AA6063)
Folding bracket, Roca, Black, Aluminium (AA6063)



Διαστάσεις / Dim (Ø - L / Strength):

- Ø20 - L150 / 30kg
- Ø20 - L247 / 30kg
- Ø20 - L392 / 30kg
- Ø20 - L544 / 30kg
- Ø25 - 161 / 35kg
- Ø25 - 252 / 55kg
- Ø25 - 402 / 60kg
- Ø25 - 549 / 80kg



33-1432

Μεντεσές με γόνατο για κομπάσο Rakego, Roca, Αλουμίνιο, φυσικό και μαύρο χρώμα
Hinge for Rakego folding bracket, Roca, Aluminium, anodized natural and black

Διαστάσεις / Dim (WxLxTh / h):
25x20x3 / h46



07

Γωνίες

Brackets



33-2002

Γωνία SU, Ανοξείδωτη AISI 316
Bracket SU, St. Steel AISI 316

Διαστάσεις / Dim (LxWxTh):

SU30 - 31x12x2,5

SU45 - 46x13x3,0

SU60 - 61x15x3,0

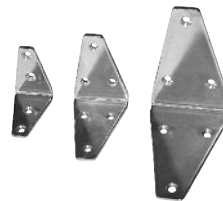

33-2004

Γωνία SV, Ανοξείδωτη AISI 316
Bracket SV, St. Steel AISI 316

Διαστάσεις / Dim (LxWxTh):

SV40 - 41x25x3,0

SV55 - 56x36x3,0

SV80 - 80x52x4,0



33-2005

Γωνία B.T., Takigen,
Ανοξείδωτη AISI 304
Heavy duty bracket, Takigen,
St. Steel AISI 304

Διαστάσεις / Dim (LxWxTh):

B.T. 85 - 69x86x15

B.T. 120 - 100x120x15

B.T. 180 - 149x180x15

B.T. 240 - 139x240x18

B.T. 300 - 239x300x20

B.T. 380 - 318x380x23

B.T. 480 - 400x480x30

TAKIGEN



33-2006

Γωνία, SL, Ανοξείδωτη AISI 304
Bracket, SL, St. Steel AISI 304

Διαστάσεις / Dim (LxWxTh):

L20 - 20x20x2,0

L25 - 25x25x2,0

L30 - 30x30x2,0

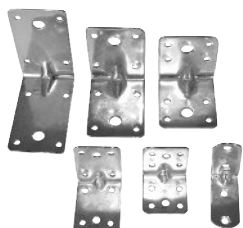

33-2007

Γωνία B.T., SL, Ανοξείδωτη AISI 304
Heavy duty bracket, SL, St. Steel AISI 304

Διαστάσεις / Dim (L1xL2xWxTh):

L40 - 40x40x40x2,0

L50 - 50x50x25x2,0

L50 - 50x50x40x2,0

L60 - 60x60x55x2,0

L70 - 70x70x55x2,0

L90 - 90x90x55x2,0

L120 - 120x120x100x3

L150 - 150x150x100x3



35-2008

Γωνία B.T., Ανοξείδωτη AISI 316
Heavy duty bracket, St. Steel AISI 316

Διαστάσεις / Dim (LxWxTh):

150x30x5 250x30x5

200x30x5 300x30x5

08

Αξεσουάρ κουκέτας Pulman bed accessories



Κρεμαστράκια Deck hooks



33-2501

Κρεμαστράκι μίνι, Ανοξείδωτο
Deck hook, St. Steel

Διαστάσεις / Dim (WxLxH):
17x27x10



33-2502

Κρεμαστράκι, Ανοξείδωτο
Deck hook, St. Steel

Διαστάσεις / Dim (WxLxH):
10x30x37



33-2504

Κρεμαστράκι, Ανοξείδωτο
Deck hook, St. Steel

Διαστάσεις / Dim (WxLxH):
13x30x35



33-2507

Κρεμαστράκι, Ανοξείδωτο
Deck hook, St. Steel

Διαστάσεις / Dim (WxLxH):
13x35x70



33-2509

Κρεμαστράκι, Ανοξείδωτο
Deck hook, St. Steel AISI

Διαστάσεις / Dim (WxLxH):
25x95x53



33-2510

Κρεμαστράκι τύπου Stayer, Ανοξείδωτο
Spring fender hook, St. Steel

Διαστάσεις / Dim (WxLxH):
33x31x35 33x31x45

**33-2511**

Κρεμαστράκι, Lamp, Ανοξείδωτο
Deck hook, Lamp, St. Steel

Διαστάσεις / Dim (WxLxH):

35x65x22 45x80x30

LAMP
by XGARD

**33-2513**

Κρεμαστράκι, Ανοξείδωτο
Deck hook, St. Steel

Διαστάσεις / Dim:

H60

**33-2514**

Κρεμαστράκι, Jaekel, Ανοξείδωτο
Deck hook, Jaekel, St. Steel

Διαστάσεις / Dim (DxWxLxH):

6x9x16x50 8x9x24x60

**33-2515**

Κρεμαστράκι, Jaekel, Ανοξείδωτο
Deck hook, Jaekel, St. Steel

Διαστάσεις / Dim (WxLxH):

9x27x23 10x34x30

**33-2516**

Κρεμαστράκι, Jaekel, Ανοξείδωτο
Deck hook, Jaekel, St. Steel

Διαστάσεις / Dim (WxLxH):

10x70x40 15x120x65 14x200x110

**33-2517**

Κρεμαστράκι, Jaekel, Ανοξείδωτο
Deck hook, Jaekel, St. Steel

Διαστάσεις / Dim (WxLxH):

10x74x50 13x115x80 14x220x120

**33-2518**

Κρεμαστράκι, Ανοξείδωτο
Fender hook, St. Steel

Διαστάσεις / Dim (WxLxH):

22x24x2026x30x20 - θηλιά/noose Ø10

**33-2520**

Κρεμαστράκι, Ανοξείδωτο
Deck hook, St. Steel

Διαστάσεις / Dim (WxLxH):

10x35x70

**33-2521**

Κρεμαστράκι, Ανοξείδωτο
Cabin hook, St. Steel

Διαστάσεις / Dim):

Ø28 - 47x37 035 - 35x44

**33-2523**

Κρεμαστράκι, Ανοξείδωτο
Deck hook, St. Steel

Διαστάσεις / Dim (WxLxH):

11x30x25 14x40x32

**33-2524**

Κρεμαστράκι, Ανοξείδωτο
Deck hook, St. Steel

Διαστάσεις / Dim (WxLxH):

7x25x20 9x30x30

**33-2525**

Κρεμαστράκι, Ανοξείδωτο
Deck hook, St. Steel

Διαστάσεις / Dim (WxLxH):

8x33x32



33-2527

Κρεμαστράκι, Jaekel, Ανοξείδωτο
Deck hook, Jaekel, St. Steel

Διαστάσεις / Dim (WxLxH):
20x35x40



33-2528

Κρεμαστράκι διπλό, Ανοξείδωτο
Deck hook double, St. Steel



33-2529

Κρεμαστράκι, Ανοξείδωτο
Hook, St. Steel

Διαστάσεις / Dim (WxLxH):
11x30x25 16x40x32



33-2530

Κρεμαστράκι, Ανοξείδωτο
Deck hook, St. Steel AISI

Διαστάσεις / Dim (WxLxH):
20x65x80



33-2533

Κρεμαστράκι, Lamp, Ανοξείδωτο
Cabin hook, Lamp, St. Steel

Διαστάσεις / Dim (WxLxH):
W50 W70



33-2536

Κρεμαστράκι, Ανοξείδωτο
Deck hook, St. Steel

Διαστάσεις / Dim (WxLxH):
20x85x62



33-2537

Κρεμαστράκι, Ανοξείδωτο
Deck hook, St. Steel

Διαστάσεις / Dim (WxLxH):
40x38x37



33-0912

Κρίκος διπλός κρέμασης L125mm,
Ανοξείδωτος AISI 316
Double ring for hanging L125mm,
St. Steel 316



33-1001

Γαντζάκι "S", CIM, Ανοξείδωτο AISI 316
"S" hook, CIM, St. Steel 316

Διαστάσεις / Dim:

Ø3,0	Ø4,0	Ø6,0	Ø8,0	Ø10,0
Ø3,5	Ø5,0	Ø7,0	Ø9,0	



33-1002

Γαντζάκι "S", King, Ανοξείδωτο AISI 316
"S" hook, King, St. Steel 316

Διαστάσεις / Dim:

Ø2,0x19	Ø3,0x30	Ø5,0x43	Ø8,0x67
Ø2,5x22	Ø4,0x36	Ø6,0x50	Ø10,0x85

Βάσεις Bases



33-0951

Βάση στήριξης κρεβατιού με γωνία, Ανοξείδωτη
Holding corner base, St. Steel



33-0952

Γάντζος κρεβατιού με γωνία, Β.Τ., Ανοξείδωτος
Heavy duty holding corner hook, St. Steel



33-0953

Γάντζος-στήριγμα κρεβατιού, Ανοξείδωτος
Holding hook, St. Steel



33-0901

Βάση τηλεφώνου για τοίχο, Takigen, Ανοξείδωτη AISI 304
Wall base for telephone, Takigen, St. Steel 304

Διαστάσεις / Dim (WxL):
120x130

TAKIGEN

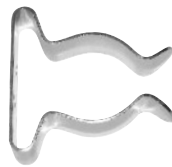

33-0903

Βάση φθορίου, Ανοξείδωτη AISI 316
Boat hook holder, St. Steel 316

Διαστάσεις / Dim:
Ø25 Ø32



33-0908

Βάση, Ανοξείδωτη AISI 316
Base, St. Steel 316



33-0909-76

Πλακάκι παραλληλογραμμο με 2 τρύπες, Ανοξείδωτο AISI 316
Rectangular plate with 2 holes, St. Steel 316

Διαστάσεις / Dim (LxWxTh):
76x31x4



33-0909-79

Πλακάκι παραλληλογραμμο με 4 τρύπες, Ανοξείδωτο AISI 316
Rectangular plate with 4 holes, St. Steel 316

Διαστάσεις / Dim (LxWxTh):
79x44x4



33-0910

Πλακάκι στρογγυλό, Ανοξείδωτο AISI 316
Rounded plate, St. Steel 316

Διαστάσεις / Dim (D-Th):
Ø60 - 4 Ø70 - 4 Ø74 - 4

Αξεσουάρ κουκέτας Pulman bed accessories

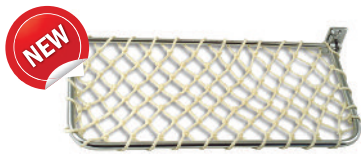

33-0919

Δίκτυ αναδιπλούμενο με στοπ,
Razeto & Casareto, chrome
Tilting rack for magazines with stop spring,
Razeto & Casareto, chrome

Διαστάσεις / Dim:

410x180



33-0920

Δίκτυ αναδιπλούμενο με στοπ, Razeto &
Casareto, chrome
Tilting rack for magazines with stop spring,
Razeto & Casareto, chrome ?

Διαστάσεις / Dim:

350x240



33-0921

Κιγκλίδωμα προστασίας κουκέτας,
Razeto & Casareto, Ανοξείδωτο ?
Articulated antirolling rail,
Razeto & Casareto, St. Steel ?

Διαστάσεις / Dim:

450x220 - Ø18 620x350 - Ø23

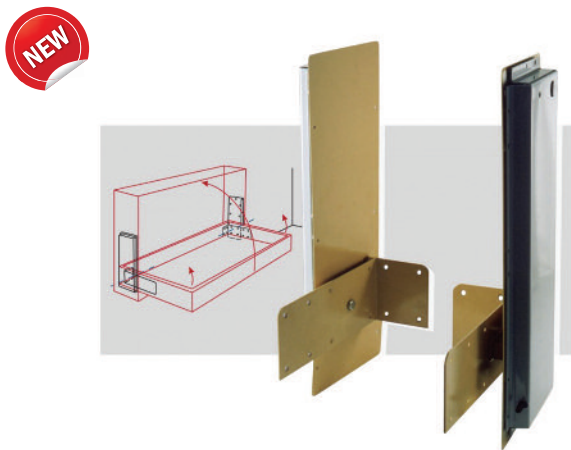

34-5100

Ζεύγος μεντεσέδων ανάκλισης κουκέτας,
Razeto & Casareto
Device for tilting beds, Pair of steel hinges,
Razeto & Casareto

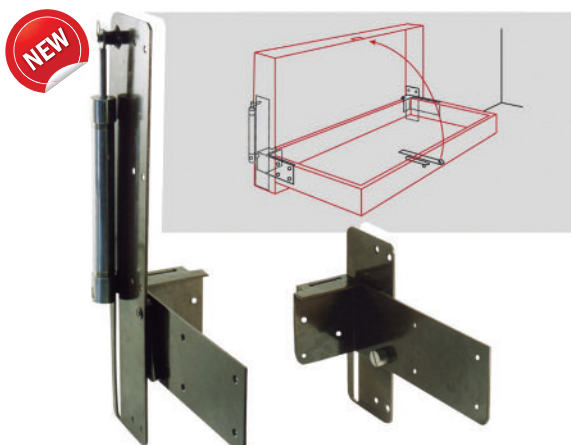

34-5101

Σύστημα ανάκλισης κουκέτας:
Ζεύγος μεντεσέδων ανάκλισης κουκέτας,
Αμορτισέρ μεντεσέ (34-5102)
και κλείστρο κουκέτας (34-5103), Razeto & Casareto
Device for tilting beds:
Pair of steel hinges, Damper (34-5102) and
Lock with flush handle and push button (34-5103),
Razeto & Casareto



09

Ζεμπερέκια

Door hooks

**33-2101**

Ζεμπερέκι Ø6, Ανοξείδωτο AISI 316
 Door hook, St. Steel AISI 316

Διαστάσεις / Dim:

L60	L100	L150
L80	L120	L200

**33-2102**

Ζεμπερέκι Β.Τ., Ανοξείδωτο AISI 316
 Heavy duty door hook, St. Steel AISI 316

Διαστάσεις / Dim:

L80	L100
-----	------

**33-2103**

Ζεμπερέκι διπλό σπάσιμο,
 Ανοξείδωτο AISI 316
 Door hook, St. Steel AISI 316

Διαστάσεις / Dim:

L100

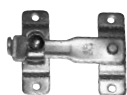
**33-2104**

Ζεμπερέκι, Takigen, Ανοξείδωτο AISI 304
 Door hook, Takigen, St. Steel AISI 304

Διαστάσεις / Dim:

L30	L55	L80	L120
L45	L60	L100	

TAKIGEN**33-2108**

Ζεμπερέκι, Jaekel,
 Ανοξείδωτο AISI 304
 Door hook, Jaekel,
 St. Steel AISI 304

**33-2109**

Ζεμπερέκι για φιλιστρίνη, Olcese Ricci,
 Ανοξείδωτο AISI 316
 Door hook for porthole, Olcese Ricci,
 St. Steel AISI 316

**33-2110**

Ζεμπερέκι κλειδαριάς, Razeto & Casareto,
 Brass chrome plated
 Door hook, Razeto & Casareto,
 Brass chrome plated

**33-2111**

Στήριγμα για ζεμπερέκι κλειδαριάς,
 Razeto & Casareto, Brass chrome plated
 Hook holder, Razeto & Casareto,
 Brass chrome plated

**33-2112**

Ζεμπερέκι, Olcese Ricci, Ανοξείδωτο
 Door hook, Olcese Ricci, St. Steel

Διαστάσεις / Dim:

L150

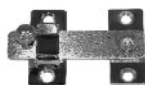
**33-2114**

Ζεμπερέκι, Ανοξείδωτο
 Door hook, St. Steel

Διαστάσεις / Dim:

Ø70

10

Σύρτες

Barrell bolts



33-2303



Σύρτης, Ανοξείδωτος
Barrel bolt, St. Steel

Διαστάσεις / Dim (WxL):

28x125	28x255
28x155	28x305
28x205	

33-2304



Σύρτης, Ανοξείδωτος AISI 316
Barrel bolt, St. Steel AISI 316

Διαστάσεις / Dim (WxL):

30x60	38x90	38x110
-------	-------	--------

33-2305



Σύρτης, Ανοξείδωτος AISI 316
Barrel bolt, St. Steel AISI 316

Διαστάσεις / Dim (WxL):

30x60

33-2306



Σύρτης, Ανοξείδωτος AISI 304
Barrel bolt, St. Steel AISI 304

Διαστάσεις / Dim (WxL):

30x55	70x97	70x113	65x150
-------	-------	--------	--------

33-2309



Σύρτης, Takigen, Ανοξείδωτος AISI 304
Barrel bolt, Takigen, St. Steel AISI 304

Διαστάσεις / Dim (WxL):

20x25	30x48	45x80
25x32	38x60	50x75

TAKIGEN

33-2310

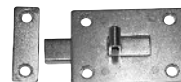

Σύρτης, Takigen, Ανοξείδωτος AISI 304
Barrel bolt, Takigen, St. Steel AISI 304

Διαστάσεις / Dim (WxL):

20x25	30x48	45x80
25x32	38x60	50x75

TAKIGEN

33-2311

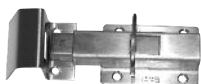

Σύρτης, Takigen, Ανοξείδωτος AISI 304
Barrel bolt, Takigen, St. Steel AISI 304

Διαστάσεις / Dim (WxL):

40x110

TAKIGEN

33-2312



Σύρτης, Jaekel, Ανοξείδωτος AISI 304
Barrel bolt, Takigen, St. Steel AISI 304

Διαστάσεις / Dim (WxL):

38x140

**33-2315**

Σύρτης, Ανοξείδωτος AISI 316
 Barrel bolt, St. Steel AISI 316

Διαστάσεις / Dim (WxL):
 38x50

**33-2316**

Σύρτης, Ανοξείδωτος AISI 304
 Barrel bolt, St. Steel AISI 304

Διαστάσεις / Dim (WxL):
 30x60

**33-2317**

Σύρτης, Jaekel, Ανοξείδωτος AISI 304
 Barrel bolt, Takigen, St. Steel AISI 304

Διαστάσεις / Dim (WxL):
 46x112

**33-2319**

Σύρτης τετράγωνος W25,
 Ανοξείδωτος AISI 316
 Barrel bolt square W25,
 St. Steel AISI 316

Διαστάσεις / Dim:
 L65 L90 L125

**33-2320**

Σύρτης πόρτας με αλυσίδα, Roca,
 Ανοξείδωτος AISI 316
 Door chain, Roca St. Steel AISI 316

Διαστάσεις / Dim:
 108x32

**33-2321**

Σύρτης πόρτας με αλυσίδα, Lamp,
 Ανοξείδωτος
 Door chain, Lamp St. Steel

Διαστάσεις / Dim:
 L1.00 L.2000

**33-2318**

Σύρτης χωνευτός, Ανοξείδωτος AISI 304
 Barrel bolt, St. Steel AISI 304

Διαστάσεις / Dim (WxL):
 22x147 22x202 22x252 25x302

**33-2331**

Σύρτης WC, Ανοξείδωτος AISI 304
 Door barrel bolt for WC, St. Steel AISI 304

**33-2332**

Σύρτης WC, Ανοξείδωτος AISI 304
 Door barrel bolt for WC, St. Steel AISI 304

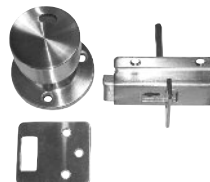
**33-2333**

Σύρτης WC, Ανοξείδωτος AISI 304
 Door barrel bolt for WC, St. Steel AISI 304

Διαστάσεις σώματος / Body dim (WxL):
 42x87

Διαστάσεις ομόλογου / Knob dim (HxD):
 60x60

**33-2334**

Μπουτόν WC, Ανοξείδωτο
 WC turn button, Ανοξείδωτο

11

Χούφτες

Lift handles



33-2201

Χούφτα τετράγωνη με ελατήριο,
Ανοξείδωτη AISI 316
Lift handle square with spring,
St. Steel AISI 316

Διαστάσεις / Dim:
38x44 55x65



33-2202

Χούφτα τετράγωνη,
Ανοξείδωτη AISI 316
Lift handle square,
St. Steel AISI 316

Διαστάσεις / Dim:
55x65

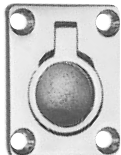

33-2212

Χούφτα κυτή,
Ανοξείδωτη AISI 316
Lift handle,
St. Steel AISI 316

Διαστάσεις / Dim:
35x44 44x62



33-2204

Χούφτα παραλληλόγραμμη,
Ανοξείδωτη AISI 316
Lift handle rectangular,
St. Steel AISI 316

Διαστάσεις / Dim:
75x58



33-2205

Χούφτα με ελατήριο,
Ανοξείδωτη AISI 316
Lift handle with spring,
St. Steel AISI 316

Διαστάσεις / Dim:
75x58



33-2206

Χούφτα κυτή,
Ανοξείδωτη AISI 316
Lift handle,
St. Steel AISI 316

Διαστάσεις / Dim:
76x56



33-2208

Χούφτα με ελατήριο,
Ανοξείδωτη AISI 316
Lift handle with spring,
St. Steel AISI 316



33-2209

Χούφτα με γλώσσα ελατήριο,
Ανοξείδωτη AISI 316
Lift handle with catch plate,
St. Steel AISI 316

Διαστάσεις / Dim:
37x47

**33-2210**

Χούφτα κυτή με γλώσσα ελατήριο,
Ανοξείδωτη AISI 316
Lift handle with catch plate & spring,
St. Steel AISI 316

Διαστάσεις / Dim:
44x62

**33-2211**

Χούφτα κωνευτή, Olcese Ricci,
Ανοξείδωτη AISI 316
Lift handle, Olcese Ricci, St. Steel AISI 316

Διαστάσεις / Dim:
65x46

**33-2213**

Χούφτα με γλώσσα ελατήριο, Takigen
Ανοξείδωτη AISI 304
Lift handle with catch plate & spring,
Takigen St. Steel AISI 304

Διαστάσεις / Dim:
30x40

TAKIGEN**33-2214**

Χούφτα στρογγυλή με ελατήριο
Roca, Ανοξείδωτη AISI 304
Round lift handle with spring, Roca,
St. Steel AISI 304

Διαστάσεις / Dim:
Ø50

**33-2234**

Χούφτα στρογγυλή με ελατήριο,
Ανοξείδωτη AISI 316
Round lift handle with spring,
St. Steel AISI 316

Διαστάσεις / Dim:
Ø55

**33-2215**

Χούφτα στρογγυλή κυτή,
Ανοξείδωτη AISI 316
Ring pull, St. Steel AISI 316

Διαστάσεις / Dim:
Ø52

**33-2217**

Χούφτα με κλειδαριά,
Ανοξείδωτη AISI 316
Lift handle with key,
St. Steel AISI 316

Διαστάσεις / Dim:
48x54

**33-2218**

Χούφτα με κλειδαριά, Olcese Ricci,
Ανοξείδωτη AISI 316
Lift handle with key, Olcese Ricci,
St. Steel AISI 316

Διαστάσεις / Dim:
55x65

**33-2220**

Χούφτα στρογγυλή,
Ανοξείδωτη AISI 304
Round lift handle,
St. Steel AISI 304

Διαστάσεις / Dim:
Ø75

**33-2222**

Χούφτα τετράγωνη Β.Τ.,
Ανοξείδωτη AISI 304
Heavy duty square lift handle,
St. Steel AISI 304

Διαστάσεις / Dim:
89x89

**33-2223**

Χούφτα στρογγυλή, Roca,
Ανοξείδωτη AISI 316
Round lift handle, Roca,
St. Steel AISI 316

Διαστάσεις / Dim:
Ø97 / h11

**33-2225**

Χούφτα στρογγυλή με γλώσσα,
Ανοξείδωτη AISI 304
Round lift handle with catch plate,
St. Steel AISI 304

Διαστάσεις / Dim:
Ø80



33-2226

Χούφτα τετράγωνη,
Ανοξείδωτη AISI 304
Square lift handle,
St. Steel AISI 304

Διαστάσεις / Dim:
71x71



33-2228

Χούφτα στρογγυλή επίπλου,
Ανοξείδωτη AISI 304
Round lift handle for furniture,
St. Steel AISI 304

Διαστάσεις / Dim:
Ø90



33-2229

Χούφτα οβάλ επίπλου,
Ανοξείδωτη AISI 304
Oval lift handle for furniture,
St. Steel AISI 304

Διαστάσεις / Dim:
120x40

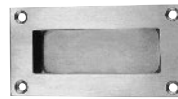

33-2230

Χούφτα παραλληλόγραμμ
επίπλου, Ανοξείδωτη AISI 304
Rectangular lift handle for furniture,
St. Steel AISI 304

Διαστάσεις / Dim:
102x51



33-2232

Χούφτα οβάλ, Ανοξείδωτη
Oval handle, St. Steel



33-2233

Χούφτα δάκρυ, Ανοξείδωτη
Furniture handle, St. Steel

Διαστάσεις / Dim:
162x44



33-2235

Χούφτα συρόμενης πόρτας οβάλ,
σατινέ, Ανοξείδωτη
Flush oval handle for sliding door,
satin, St. Steel

Διαστάσεις / Dim:
185x34

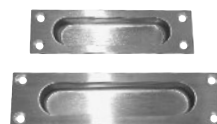

33-2237

Χούφτα παραλληλόγραμμ επίπλου,
Ανοξείδωτη AISI 304
Rectangular handle for furniture,
St. Steel AISI 304

Διαστάσεις / Dim:
120x34 150x38

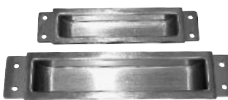

33-2238

Χούφτα παραλληλόγραμμ επίπλου,
Ανοξείδωτη AISI 304
Rectangular handle for furniture,
St. Steel AISI 304

Διαστάσεις / Dim:
100x30 138x38



33-2240

Χούφτα παραλληλόγραμμ επίπλου
με παξιμάδι ή βίδα, Ανοξείδωτη AISI 304
Rectangular lift handle for furniture with
nut or screw, St. Steel AISI 304

Διαστάσεις / Dim:
93x60 110x64 138x89



33-2241

Χούφτα για κασόνι με ελατήριο,
Takigen, Ανοξείδωτη AISI 304
Lift handle with spring, Takigen,
St. Steel AISI 304

Διαστάσεις / Dim:
86x46

TAKIGEN



33-2242

Χούφτα για κασόνι με ελατήριο,
Takigen, Ανοξείδωτη AISI 304
Lift handle with spring, Takigen,
St. Steel AISI 304

Διαστάσεις / Dim:
90x70

TAKIGEN

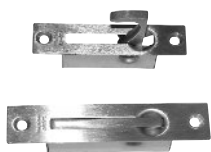
33-2243

Χούφτα για πανιόλα, Lamp, Ανοξείδωτη
Lift handle, Lamp, St. Steel

Διαστάσεις / Dim:

ST80-80x18 ST100-100x20

LAMP
by VCSHIRE

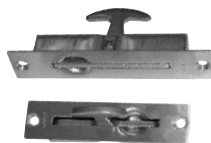
33-2244

Χούφτα για πανιόλα, Lamp, Ανοξείδωτη
Lift handle, Lamp, St. Steel

Διαστάσεις / Dim:

ST90-90x22 ST115-115x25

LAMP
by VCSHIRE

33-2245

Χούφτα για πανιόλα, Lamp, Ανοξείδωτη
Lift handle, Lamp, St. Steel

Διαστάσεις / Dim:

HR90 - 90x24 HR115 - 115x25

LAMP
by VCSHIRE

33-2246

Χούφτα για πανιόλα, Ανοξείδωτη
Lift handle, St. Steel

Διαστάσεις / Dim:

HK90 - 90x30 HK110 - 110x30

33-2250

Χούφτα αμπαριού στρογγυλή με γλώσσα,
Roca, Ανοξείδωτη AISI 316
Round latch, Roca, St. Steel AISI 316

Διαστάσεις / Dim:

Ø100

ROCA

33-2252

Χούφτα αμπαριού στρογγυλή με γλώσσα
ελατήριο, Roca, Ανοξείδωτη AISI 316
Round latch with spring, Roca,
St. Steel AISI 316

Διαστάσεις / Dim:

Ø100

ROCA

33-2254

Χούφτα αμπαριού Roca,
Ανοξείδωτη AISI 316
Latch, Roca, St. Steel AISI 316

Διαστάσεις / Dim:

Ø70

ROCA

33-2255

Χούφτα αμπαριού με καπάκι, Olcese Ricci,
Ανοξείδωτη AISI 316
Lift handle, Olcese Ricci, St. Steel AISI 316

Διαστάσεις / Dim:

102x108

OLCESE RICCI

33-2256

Χούφτα αμπαριού χυτή B.T.,
Ανοξείδωτη AISI 316
Heavy duty lift handle, St. Steel AISI 316

Διαστάσεις / Dim:

80x68

NEW

**33-2259**

Χούφτα κλειδαριά φάλκας Ø60,
Ανοξείδωτη AISI 316
Lift handle Ø60, St. Steel AISI 316

33-2261

Χούφτα αμπαριού χωρίς κλειδί,
Olcese Ricci, Ανοξείδωτη AISI 316
Lift handle without key,
Olcese Ricci, St. Steel AISI 316

Διαστάσεις / Dim:

Ø75

OLCESE RICCI

33-2262

Χούφτα αμπαριού με κλειδί,
Olcese Ricci, Ανοξείδωτη AISI 316
Lift handle with key,
Olcese Ricci, St. Steel AISI 316

Διαστάσεις / Dim:

Ø75

OLCESE RICCI



33-2263

Χούφτα στρογγυλή, Roca,
Ανοξείδωτη AISI 316
Round lift handle, Roca,
St. Steel AISI 316

Διαστάσεις / Dim:
Ø64 (SS)



33-2265

Χούφτα κυτή με γλώσσα,
Ανοξείδωτη AISI 316
Ring pull latch, St. Steel AISI 316

Διαστάσεις / Dim:
58x60



33-2270

Χούφτα αμπαριού στρογγυλή Β.Τ.,
Ανοξείδωτη AISI 316
Heavy duty round latch, St. Steel AISI 316

Διαστάσεις / Dim:
Ø78



33-2271

Χούφτα αμπαριού παραλληλόγραμμ Β.Τ.,
Ανοξείδωτη AISI 316
Heavy duty rectangular latch,
St. Steel AISI 316

Διαστάσεις / Dim:
62x77



33-2272

Χούφτα αμπαριού παραλληλόγραμμ Β.Τ.,
Ανοξείδωτη AISI 316
Heavy duty rectangular latch,
St. Steel AISI 316

Διαστάσεις / Dim:
75x96



33-2280

Χούφτα Beetle, Southco, Ανοξείδωτη
Beetle latch, Southco, St. Steel



33-2264

Χούφτα αμπαριού στρογγυλή Ø70, Roca,
Ανοξείδωτη AISI 316
Compression latch Ø70, Roca,
St. Steel AISI 316



33-2290

Χούφτα αμπαριού στρογγυλή Ø76, Roca,
Ανοξείδωτη AISI 316
Compression latch Ø76, Roca,
St. Steel AISI 316



12

Βάσεις Πέργκολας

Pergola bases

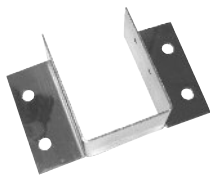
**33-2801**

Βάση πέργκολας τοίχου για δοκό 70mm,
Ανοξείδωτη
Wall fixed base for column 70mm,
St. Steel

Διαστάσεις / Dim (WxLxTh):

165x98

**33-2802**

Βάση πέργκολας δαπέδου (1τεμ.),
Ανοξείδωτη
Floor divisible base (1 piece),
St. Steel

Διαστάσεις / Dim (WxLxTh):

190x70

**33-2820**

Βάση πέργκολας για δοκό 40mm,
Ανοξείδωτη
Wall fixed base for column 40mm,
St. Steel

Διαστάσεις / Dim (Ø-L):

Ø25-205

**33-2821**

Βάση πέργκολας για δοκό 40mm,
Ανοξείδωτη
Wall fixed base for column 40mm,
St. Steel AISI 316

Διαστάσεις / Dim (Ø-L):

Ø25-205

**33-2831**

Βάση πέργκολας για δοκό 40mm,
Ανοξείδωτη
Wall fixed base for column 40mm,
St. Steel

Διαστάσεις / Dim (Ø-L):

Ø25-210

**33-2832**

Βάση πέργκολας για δοκό 40mm,
Ανοξείδωτη
Wall fixed base for column 40mm,
St. Steel

Διαστάσεις / Dim (Ø-L):

Ø25-210

**33-2833**

Βάση πέργκολας για δοκό 40mm,
Ανοξείδωτη
Wall fixed base for column 40mm,
St. Steel

Διαστάσεις / Dim (Ø-L):

Ø25-220

13

Καταβάτες

Toggle latches



33-2401

Καταβάτης, Ανοξείδωτος AISI 316
Toggle latch, St. Steel AISI 316

Διαστάσεις / Dim (WxL):
23x51



33-2402

Καταβάτης, Olcese Ricci,
Ανοξείδωτος AISI 316
Toggle latch, Olcese Ricci, St. Steel AISI 316

Διαστάσεις / Dim (WxL):
28x78



33-2405

Καταβάτης, Ανοξείδωτος AISI 316
Toggle latch, St. Steel AISI 316

Διαστάσεις / Dim (WxL):
30x60



33-2406

Καταβάτης, Ανοξείδωτος AISI 316
Safety hasp, St. Steel AISI 316

Διαστάσεις / Dim (WxL):
30x68



33-2406-01

Καταβάτης, Roca, Ανοξείδωτος AISI 316
Safety hasp, Roca, St. Steel AISI 316

Διαστάσεις / Dim (WxL):
30x68



33-2407

Καταβάτης, Ανοξείδωτος AISI 316
Safety hasp, St. Steel AISI 316

Διαστάσεις / Dim (WxL):
30x78



33-2407-1

Καταβάτης, Roca, Ανοξείδωτος AISI 316
Safety hasp, Roca, St. Steel AISI 316

Διαστάσεις / Dim (WxL):
30x78



33-2408

Καταβάτης, Ανοξείδωτος AISI 316
Safety hasp, St. Steel AISI 316

Διαστάσεις / Dim (WxL):
30x68



33-2409

Καταβάτης, Mavi Mare,
Ανοξείδωτος AISI 316
Safety hasp, Mavi Mare, St. Steel AISI 316

Διαστάσεις / Dim (WxL):
30x80



**33-2410**

Καταβάτης, Jaekel, Ανοξείδωτος AISI 316
 Safety hasp, Jaekel, St. Steel AISI 316

Διαστάσεις / Dim (WxL):

22x40	24x65	35x100
22x50	28x75	40x120

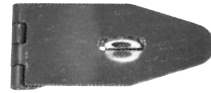
**33-2411**

Καταβάτης, Mavi Mare,
 Ανοξείδωτος AISI 316
 Safety hasp, Mavi Mare, St. Steel AISI 316

Διαστάσεις / Dim (WxL):

42x92

**33-2412**

Καταβάτης, Ανοξείδωτος AISI 316
 Safety hasp, St. Steel AISI 316

Διαστάσεις / Dim (WxL):

25x70

**33-2430**

Καταβάτης, Mavi Mare,
 Ανοξείδωτος AISI 316
 Toggle latch, Mavi Mare, St. Steel AISI 316

Διαστάσεις / Dim (WxL):

15x85

**33-2431**

Καταβάτης, Razeto & Casareto,
 Ανοξείδωτος AISI 316
 Toggle latch, Razeto & Casareto,
 St. Steel AISI 316

Διαστάσεις / Dim (WxL):

18x90

**33-2433**

Καταβάτης, Roca, Ανοξείδωτος AISI 304
 Toggle latch, Roca, St. Steel AISI 304

Διαστάσεις / Dim (WxL):

30x60

**33-2434**

Καταβάτης, Ανοξείδωτος AISI 316
 Toggle latch, St. Steel AISI 316

Διαστάσεις / Dim (WxL):

30x60

**33-2435**

Καταβάτης, Ανοξείδωτος AISI 316
 Toggle latch, St. Steel AISI 316

Διαστάσεις / Dim (WxL):

28x98

**33-2436**

Καταβάτης, Roca, Ανοξείδωτος AISI 304
 Toggle latch, Roca, St. Steel AISI 304

Διαστάσεις / Dim (WxL):

30x90

**33-2432**

Καταβάτης, Ανοξείδωτος AISI 316
 Toggle latch, St. Steel AISI 316

Διαστάσεις / Dim (WxL):

30x90

**33-2437**

Καταβάτης, Ανοξείδωτος AISI 316
 Toggle latch, St. Steel AISI 316

Διαστάσεις / Dim (WxL):

20x98

**33-2438**

Καταβάτης, Olcese Ricci,
 Ανοξείδωτος AISI 316
 Toggle latch, Olcese Ricci, St. Steel AISI 316

Διαστάσεις / Dim (WxL):

20x95



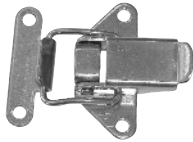

33-2439

Καταβάτης, Ανοξείδωτος AISI 316
Toggle latch, St. Steel AISI 316

Διαστάσεις / Dim (WxL):
40x45



33-2440

Καταβάτης, Ανοξείδωτος AISI 316
Toggle latch, St. Steel AISI 316

Διαστάσεις / Dim (WxL):
13x52



33-2441

Καταβάτης, Ανοξείδωτος AISI 316
Toggle latch, St. Steel AISI 316

Διαστάσεις / Dim (WxL):
20x90



33-2442

Καταβάτης, Ανοξείδωτος AISI 316
Toggle latch, St. Steel AISI 316

Διαστάσεις / Dim (WxL):
20x85



33-2443

Καταβάτης, Ανοξείδωτος AISI 316
Toggle latch, St. Steel AISI 316

Διαστάσεις / Dim (WxL):
15x85



33-2444

Καταβάτης, Takigen, Ανοξείδωτος AISI 304
Toggle latch, Takigen, St. Steel AISI 304

Διαστάσεις / Dim (WxL):
14x37

TAKIGEN



33-2445

Καταβάτης, Takigen, Ανοξείδωτος AISI 304
Toggle latch, Takigen, St. Steel AISI 304

Διαστάσεις / Dim (WxL):
10x30



33-2446

Καταβάτης, Ανοξείδωτος AISI 316
Toggle latch, St. Steel AISI 316

Διαστάσεις / Dim (WxL):
20x110



33-2447

Καταβάτης, Ανοξείδωτος AISI 316
Toggle latch, St. Steel AISI 316

Διαστάσεις / Dim (WxL):
30x70

TAKIGEN



33-2448

Καταβάτης, Olcese Ricci,
Ανοξείδωτος AISI 316
Toggle latch, Olcese Ricci, St. Steel AISI 316

Διαστάσεις / Dim (WxL):
15x75



33-2448a

Καταβάτης, Ανοξείδωτος AISI 316
Toggle latch, St. Steel AISI 316

Διαστάσεις / Dim (WxL):
30x135

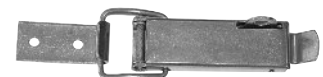

33-2449

Καταβάτης, Olcese Ricci,
Ανοξείδωτος AISI 316
Toggle latch, Olcese Ricci, St. Steel AISI 316

Διαστάσεις / Dim (WxL):
15x75 23x100 30x135

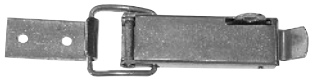
**33-2449a**

Καταβάτης, Ανοξείδωτος AISI 316
Toggle latch, St. Steel AISI 316

Διαστάσεις / Dim (WxL):
30x135

**33-2450**

Καταβάτης, Takigen, Ανοξείδωτος AISI 304
Toggle latch, Takigen, St. Steel AISI 304

Διαστάσεις / Dim (WxL):
14x47

**33-2451**

Καταβάτης, Takigen, Ανοξείδωτος AISI 304
Toggle latch, Takigen, St. Steel AISI 304

Διαστάσεις / Dim (WxL):
16x52

TAKIGEN**TAKIGEN****33-2452**

Καταβάτης, Takigen, Ανοξείδωτος AISI 304
Toggle latch, Takigen, St. Steel AISI 304

Διαστάσεις / Dim (WxL):
30x80 30x110 30x150

**33-2453**

Καταβάτης, Takigen, Ανοξείδωτος AISI 304
Toggle latch, Takigen, St. Steel AISI 304

Διαστάσεις / Dim (WxL):
22x75

**33-2454**

Καταβάτης, Ανοξείδωτος AISI 316
Toggle latch, St. Steel AISI 316

Διαστάσεις / Dim (WxL):
30x70

TAKIGEN**TAKIGEN****33-2455**

Καταβάτης, Takigen, Ανοξείδωτος AISI 304
Toggle latch, Takigen, St. Steel AISI 304

Διαστάσεις / Dim (WxL):
30x95

**33-2456**

Καταβάτης, Takigen, Ανοξείδωτος AISI 304
Toggle latch, Takigen, St. Steel AISI 304

Διαστάσεις / Dim (WxL):
30x130

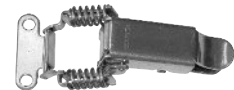
**33-2457**

Καταβάτης, Takigen, Ανοξείδωτος AISI 304
Toggle latch clip with lock, Takigen,
St. Steel AISI 304

Διαστάσεις / Dim (WxL):
16x60 25x75

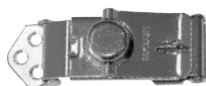
TAKIGEN**TAKIGEN****TAKIGEN****33-2458**

Καταβάτης, Takigen, Ανοξείδωτος AISI 304
Toggle latch, Takigen, St. Steel AISI 304

Διαστάσεις / Dim (WxL):
25x60 25x70 30x80

**33-2459**

Καταβάτης, Jaekel, Ανοξείδωτος AISI 304
Toggle latch, Jaekel, St. Steel AISI 304

Διαστάσεις / Dim (WxL):
30x95

**33-2460**

Καταβάτης, Roca, Ανοξείδωτος AISI 304
Toggle latch, Roca, St. Steel AISI 304

Διαστάσεις / Dim (WxL):
25x70

TAKIGEN**ROCA**



33-2461

Καταβάτης, Ανοξείδωτος AISI 304
Toggle latch, St. Steel AISI 304

Διαστάσεις / Dim (WxL):
25x120



33-2462

Καταβάτης, Roca, Ανοξείδωτος AISI 304
Toggle latch, Roca, St. Steel AISI 304

Διαστάσεις / Dim (WxL):
20x60



33-2464

Καταβάτης κλειδαριά, Lamp,
Ανοξείδωτος AISI 304
Lock toggle latch, Lamp, St. Steel AISI 304

Διαστάσεις / Dim (WxL):
52x65



33-2463

Καταβάτης, Roca, Ανοξείδωτος AISI 316
Hood latch, Roca, St. Steel AISI 316

Διαστάσεις / Dim:
W23 - L93 / 105
W31 - L145-155



33-2465

Καταβάτης λουκέτου,
Ανοξείδωτος AISI 304
Lock toggle latch, St. Steel AISI 304

Διαστάσεις / Dim (WxL):
15x75

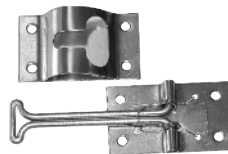

33-2474

Καταβάτης, Ανοξείδωτος AISI 316
Toggle latch, St. Steel AISI 316

Διαστάσεις / Dim (WxL):
45x135

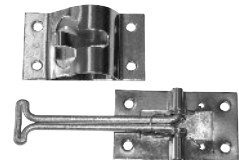

33-2475

Καταβάτης, Ανοξείδωτος AISI 316
Toggle latch, St. Steel AISI 316

Διαστάσεις / Dim (WxL):
45x135

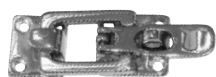

33-2480

Καταβάτης, Ανοξείδωτος AISI 316
Toggle latch, St. Steel AISI 316

Διαστάσεις / Dim (WxL):
28x77



33-2481

Καταβάτης, Ανοξείδωτος AISI 316
Toggle latch, St. Steel AISI 316

Διαστάσεις / Dim (WxL):
28x77



33-2485

Καταβάτης, Ανοξείδωτος AISI 316
Toggle latch, St. Steel AISI 316

Διαστάσεις / Dim (WxL):
38x80

**33-2486**

Καταβάτης, Ανοξείδωτος AISI 316
Toggle latch, St. Steel AISI 316

Διαστάσεις / Dim (WxL):
45x110

**33-2489**

Καταβάτης, Ανοξείδωτος AISI 316
Toggle latch, St. Steel AISI 316

Διαστάσεις / Dim (WxL):
38x72

**33-2490**

Καταβάτης, Ανοξείδωτος AISI 304
Toggle latch, St. Steel AISI 304

Διαστάσεις / Dim (WxL):
31x87

**33-2491**

Καταβάτης, Ανοξείδωτος AISI 304
Toggle latch, St. Steel AISI 304

Διαστάσεις / Dim (WxL):
35x110

**33-2492**

Καταβάτης, Roca, Ανοξείδωτος AISI 304
Toggle latch, Roca, St. Steel AISI 304

Διαστάσεις / Dim (WxL):
26x75 40x130 60x190

**33-2488**

Καταβάτης, Ανοξείδωτος AISI 316
Toggle latch, St. Steel AISI 316

Διαστάσεις / Dim (WxL):
26x80 40x135 60x180

**33-2494**

Καταβάτης, Ανοξείδωτος AISI 304
Toggle latch, St. Steel AISI 304

Διαστάσεις / Dim (WxL):
40x110

**33-2495**

Καταβάτης, Ανοξείδωτος AISI 304
Toggle latch, St. Steel AISI 304

Διαστάσεις / Dim (WxL):
45x75

**33-2496**

Καταβάτης, Roca, Ανοξείδωτος AISI 304,
Λάστιχο (CR)
Hood latch, Roca, St. Steel AISI 304,
Rubber (CR)

Διαστάσεις / Dim (WxL):
32x130

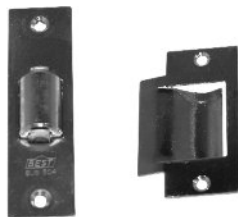
**33-3240**

Σουστάκι, Ανοξείδωτο
Door catch, St. Steel

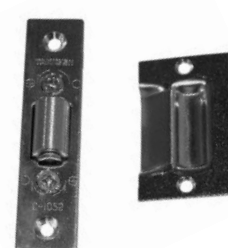
**33-3241**

Σουστάκι, Takigen, Ανοξείδωτο
Door catch, Takigen, St. Steel

14

Στοπ πόρτας

Door holders

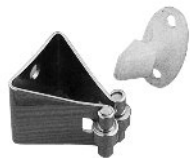

33-3201

Στοπ πόρτας, Olcese Ricci,
Ανοξείδωτο AISI 316
Door stop, Olcese Ricci,
St. Steel AISI 316

Διαστάσεις / Dim:

h20 h30 h60



33-3203

Στοπ πόρτας μαγνήτης,
Razeto & Casareto
Magnetic door holder,
Razeto & Casareto

Διαστάσεις / Dim:

h37 h48 h75



33-3204

Στοπ πόρτας,
Razeto & Casareto,
Chrome brass plated
Door holder, Razeto & Casareto,
Chrome brass plated

Διαστάσεις / Dim:

h45



33-3205

Στοπ πόρτας, Razeto & Casareto,
Chrome brass plated
Door holder, Razeto & Casareto,
Chrome brass plated

Διαστάσεις / Dim:

h70

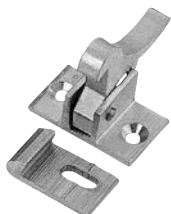

33-3206

Κοκοράκι,
Ανοξείδωτο AISI 316
Elbow catch,
St. Steel AISI 316

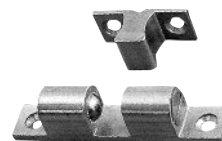

33-3207

Στοπ ασφαλείας ντουλαπιών,
Ανοξείδωτο AISI 316
Closet stop, St. Steel AISI 316

Διαστάσεις / Dim:

L40 L60
L50 L70



33-3208

Στοπ πόρτας, aller-retour,
Ανοξείδωτο AISI 316
Door holder alle-retour,
St. Steel AISI 316



33-3209

Στοπ πόρτας, Ανοξείδωτο AISI 304
Door holder, St. Steel AISI 304

**33-3229**

Στοπ πόρτας, Ανοξείδωτο
 Door holder, St. Steel

**33-3230**

Στοπ πόρτας με γάντζο, Ανοξείδωτο
 Door stop with hook, St. Steel

**33-3233**

Στοπ πόρτας, Ανοξείδωτο
 Door holder, St. Steel

**33-2113**

Κλείστρο πόρτας, Ανοξείδωτο
 Door latch, St. Steel

**33-2221**

Στοπ πόρτας, Ανοξείδωτο
 Door holder, St. Steel

**33-3232**

Κλείστρο ελατηριωτό
 για ντουλάπι, Ανοξείδωτο
 Push latch with spring, St. Steel

**33-2120**

Κλείστρο ντουλαπιού, Lamp,
 Πλαστικό σε λευκό, καφέ, γκρι
 Closet hook, Lamp,
 Plastic in white, brown, grey

Διαστάσεις / Dim:

L66

LAMP
 by MCORMAC

**33-2120**

Κλείστρο ντουλαπιού, Lamp,
 Ανοξείδωτο
 Closet hook, Lamp, St. Steel

Διαστάσεις / Dim:

L66

LAMP
 by MCORMAC

15

Σήματα πόρτας Sign plates



33-3251

Σήμα WC ανδρών,
Ανοξείδωτο AISI 304
Sign plate WC for men,
St. Steel AISI 304

Διαστάσεις / Dim:
100x100x1,5



33-3252

Σήμα WC γυναικών,
Ανοξείδωτο AISI 304
Sign plate WC for women,
St. Steel AISI 304

Διαστάσεις / Dim:
100x100x1,5



33-3253

Σήμα WC,
Ανοξείδωτο AISI 304
Sign plate WC,
St. Steel AISI 304

Διαστάσεις / Dim:
170x130x1,5



33-3254

Σήμα WC ανδρών,
Ανοξείδωτο AISI 304
Sign plate WC for men,
St. Steel AISI 304

Διαστάσεις / Dim:
76x1,5



33-3255

Σήμα WC γυναικών,
Ανοξείδωτο AISI 304
Sign plate WC for women, St.
Steel AISI 304

Διαστάσεις / Dim:
76x1,5



33-3256

Σήμα WC,
Ανοξείδωτο AISI 304
Sign plate WC,
St. Steel AISI 304

Διαστάσεις / Dim:
76x1,5



33-3257

Σήμα WC για άτομα με ειδικές
ανάγκες, Ανοξείδωτο AISI 304
Sign plate WC for disabled
people, St. Steel AISI 304

Διαστάσεις / Dim:
76x1,5



33-3258

Σήμα WC για περιποίηση
βρεφών, Ανοξείδωτο AISI 304
Sign plate WC for baby change,
St. Steel AISI 304

Διαστάσεις / Dim:
76x1,5



33-3259

Σήμα PUSH,
Ανοξείδωτο AISI 304
Sign plate PUSH,
St. Steel AISI 304

Διαστάσεις / Dim:
76x1,5



33-3260

Σήμα PULL,
Ανοξείδωτο AISI 304
Sign plate PULL,
St. Steel AISI 304

Διαστάσεις / Dim:
76x1,5



33-3261

Σήμα FIRE DOOR, Ανοξείδωτο
Sign plate FIRE DOOR,
St. Steel

Διαστάσεις / Dim:
76x1,5

16

Εξαρτήματα συρόμενης πόρτας

Sliding door hardware

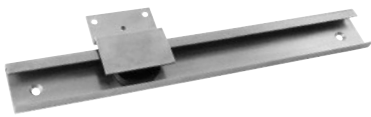
**33-1101**

Ράγα οροφής 3422, 40x14x2000,
Razeto & Casareto, Ανοξείδωτη
Guide 3422, 40x14x2000,
Razeto & Casareto, St. Steel

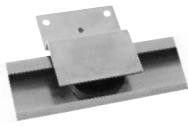
**33-1102**

Βαγόνι ράγας οροφής 3423, 40x14x2000
Razeto & Casareto, Ανοξείδωτο
Wheel pulley 3423 for guide, 40x14x2000,
Razeto & Casareto, St. Steel

**33-1103**

Ράγα δαπέδου B.T. 3424, 30x12x2000,
Razeto & Casareto, Brass nickel plated
Heavy duty wheel pulley 3424, 30x12x2000,
Razeto & Casareto, Brass nickel plated

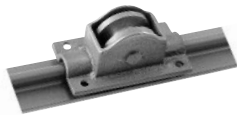
**33-1104**

Βαγόνι ράγας δαπέδου B.T. 3425,
Razeto & Casareto, Ανοξείδωτο
Guide 3425, Razeto & Casareto, St. Steel

**33-1105**

Ράγα δαπέδου 3426, 12x11x2000, Razeto
& Casareto, Brass nickel plated
Pulley 12x11x2000, Razeto & Casareto,
Brass nickel plated

**33-1106**

Βαγόνι ράγας δαπέδου 3427,
Razeto & Casareto, Ανοξείδωτο
Guide 3427, Razeto & Casareto, St. Steel

**33-1130**

Βαγόνι ράγας δαπέδου, Ανοξείδωτο
Guide, St. Steel

Διαστάσεις / Dim:

Ø42 - L100

Ø60 - L140

Ø75 - L140

17

Σιφώνια

Floor drains



33-1501

Σιφώνι Β.Τ., SCM, Ανοξείδωτο AISI 316
Heavy duty floor drain., SCM,
St. Steel AISI 316

Διαστάσεις / Dim:

Ø105 εξ./ext. - Ø75 εσωτ./int.
Ø150 εξ./ext. - Ø120 εσωτ./int.



33-1511

Σιφώνι ντουζιέρας, Ανοξείδωτο AISI 304
Shower drain, St. Steel AISI 304

Διαστάσεις / Dim:

Ø150x150 εξ./ext. - Ø135 εσωτ./int.



33-1512

Σιφώνι ντουζιέρας, Ανοξείδωτο AISI 304
Shower drain, St. Steel AISI 304

Διαστάσεις / Dim:

Ø100x100 εξ./ext. - Ø90 εσωτ./int.

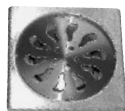

33-1521

Σιφώνι, Ανοξείδωτο AISI 304
Floor trap grating, St. Steel AISI 304

Διαστάσεις / Dim:

Ø90x90 εξ./ext. - Ø75 εσωτ./int.



33-1522

Σιφώνι, Ανοξείδωτο AISI 304
Floor trap grating, St. Steel AISI 304

Διαστάσεις / Dim:

Ø90x90 εξ./ext. - Ø75 εσωτ./int.



33-1523

Σιφώνι, Ανοξείδωτο AISI 304
Floor trap grating, St. Steel AISI 304

Διαστάσεις / Dim:

Ø122x122 εξ./ext. - Ø100 εσωτ./int.



33-1524

Σιφώνι, Ανοξείδωτο AISI 304
Floor trap grating, St. Steel AISI 304

Διαστάσεις / Dim:

Ø90 εξ./ext.- Ø75 εσωτ./int.



33-1525

Σιφώνι, Ανοξείδωτο AISI 304
Floor trap grating, St. Steel AISI 304

Διαστάσεις / Dim:

Ø90 εξ./ext.- Ø75 εσωτ./int.



33-1526

Σιφώνι, Ανοξείδωτο AISI 304
Floor trap grating, St. Steel AISI 304

Διαστάσεις / Dim:

Ø122 εξ./ext.- Ø100 εσωτ./int.

Copyright © 2019 ΚΥΡΙΑΚΟΣ ΘΕΟΔΟΣΙΑΔΗΣ ΑΕ

Όλα τα δικαιώματα διατηρούνται. Κανένα μέρος αυτής της έκδοσης (έντυπης ή ηλεκτρονικής μορφής) δεν μπορεί να αναπαραχθεί, να διανεμηθεί ή να μεταδοθεί με οποιαδήποτε μορφή ή με οποιονδήποτε τρόπο, συμπεριλαμβανομένης της φωτοαντιγραφής, εγγραφής ή άλλων ηλεκτρονικών ή μηχανικών μεθόδων, χωρίς την προηγούμενη γραπτή άδεια της εταιρείας Κ. ΘΕΟΔΟΣΙΑΔΗΣ ΑΕ, εκτός από τις περιπτώσεις σύντομων εισαγωγικών σε κριτικές και σε ορισμένες άλλες μη εμπορικές χρήσεις που επιτρέπονται από το νόμο περί πνευματικών δικαιωμάτων. Για αιτήματα αδειών, απευθυνθείτε στον εκδότη στη διεύθυνση: Κ. Θεοδοσιάδης ΑΕ, Παπαστράτου 10 & Χαϊδαρίου 13, 18545 Πειραιάς, e-mail: info@theodosiadis.gr

Copyright © 2019 by ΚΥΡΙΑΚΟΣ THEODOSIADIS SA

All rights reserved. No part of this publication (printed or electronic) may be reproduced, distributed, or transmitted in any form or by any means, including photocopying, recording, or other electronic or mechanical methods, without the prior written permission of the K. Theodosiadis SA, except in the case of brief quotations embodied in critical reviews and certain other noncommercial uses permitted by copyright law. For permission requests, write to the publisher, addressed at the address: K. Theodosiadis SA, Papastratou10 & Chaidariou 13 Str., 18545 Piraeus, Greece, e-mail: info@theodosiadis.gr

www.theodosiadis.gr

Created & Printed in EU



Κ. Θεοδοσιάδης αε
ΑΝΟΞΕΙΔΩΤΑ • ΒΙΔΕΣ • ΑΞΕΣΟΥΑΡ ΣΚΑΦΩΝ

Παπαστράτου 10 & Χαϊδαρίου 13 | 18545 Πειραιάς | τηλ.: 210 4205890 | fax: 210 4205892
Papastratou 10 & Chaidariou 13 str. | 18545 Piraeus, Greece | tel.: +30 210 4205890 | fax: +30 210 4205892
info@theodosiadis.gr | www.theodosiadis.gr