

2014

Αρματωσιά Rigging



All the stainless you need!

Περιεχόμενα

Contents

01	Συρματόσχοινα	Wire ropes	5
-----------	----------------------	-------------------	----------

Το συρματόσχοινο και τα εξαρτήματά του στη Ναυτιλία | Wire rope marine accessories

02	Εντατήρες	Rigging screws	8
	Εντατήρες για babystay Wichard	Wichard babystay adjusters	8
	Εντατήρες επιτόνου Wichard	Wichard backstay adjusters	9
	Εντατήρες επιτόνου Olcese Ricci	Olcese Ricci backstay adjusters	9
	Εντατήρες	Rigging screws	10
03	Εξαρτήματα συρματόσχοινου	Wire rope accessories	14

Το συρματόσχοινο και τα εξαρτήματά του στη Διακόσμηση | Wire Design System

04	WDS εξαρτήματα συρματόσχοινου	WDS fittings	23
05	Σύστημα ανάρτησης αναρριχώμενων φυτών	Green Line post	29
06	Σύστημα κουρτίνας “Υ”	“Υ” system curtain anchor	30

01

Συρματόσχοινα

Wire ropes



Συρματόσχοινα Ανοξείδωτα AISI 316

Τα συρματόσχοινά μας κατασκευάζονται από κλώνους υψηλής αντοχής. Οι κλώνοι γίνονται από συστροφή μονών συρμάτων ελικοειδώς. Ανάλογα με την εφαρμογή ή τη χρήση, οι κλώνοι συστρέφονται μαζί –όσοι περισσότεροι, τόσο πιο ευέλικτο το συρματόσχοινο.

Κατασκευή καλωδίων:

Αριθμός των κλώνων x Αριθμός των συρματόσχοινων ανά κλώνο.

Για παράδειγμα 1x19 ή 7x19.

Wire Ropes Stainless Steel AISI 316

Our ropes are manufactured with high tensile strands. The strands are made by twisting single wires together helically. Depending on application or use, wires are twisted together; the more wires used, the more flexible the wire rope.

Wire construction:

Number of strands x Number of wires per strand.

For example 1x19 or 7x7.

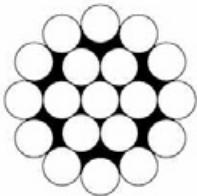

11-2402

Συρματόσχοινο 1x19, Ανοξείδωτο AISI 316

Wire rope 1x19, St. Steel AISI 316

Very stiff - Suspension & Control cables - Standing rigging

nominal Ø mm	weight per kg/100 m	tensile strength N/mm ²	calculated breaking load kN	minimum breaking load kN
1,00	0,50	1570	0,94	0,82
1,50	1,10	1570	2,11	1,86
2,00	2,00	1570	3,75	3,30
3,00	4,50	1570	8,43	7,420
4,00	8,00	1570	15,00	13,20
5,00	12,40	1570	23,40	20,60
6,00	17,80	1570	33,70	29,69
7,00	24,30	1570	45,90	40,40
8,00	31,70	1570	59,90	52,00
10,00	49,50	1500	89,55	78,80
12,00	71,30	1450	124,60	109,70
14,00	97,10	1340	158,79	137,98
16,00	127,00	1340	204,70	180,00
19,00	178,80	1260	272,00	238,00

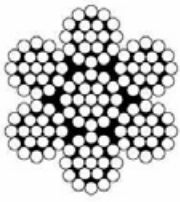

11-2402

Συρματόσχοινο 7x19, Ανοξειδωτο AISI 316
Wire rope 7x19, St. Steel AISI 316
Very flexible - Blind systems - Standing rigging - Steering cables

nominal Ø mm	weight per kg/100 m	tensile strength N/mm ²	calculated breaking load kN	minimum breaking load kN
1,00	0,38	1570	0,65	0,52
1,50	0,86	1570	1,46	1,17
2,00	1,50	1570	2,60	2,08
2,50	2,30	1570	4,07	3,26
3,00	3,50	1570	5,86	4,69
4,00	6,10	1570	10,40	8,34
5,00	9,60	1570	16,25	13,00
6,00	13,80	1570	23,40	18,76
7,00	18,70	1570	31,85	25,50
8,00	24,30	1570	41,60	33,30
10,00	38,10	1570	65,00	52,10
12,00	54,80	1570	93,70	75,00
14,00	76,40	1570	127,5	102,00
16,00	97,40	1570	166,60	133,00

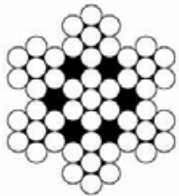

11-2404

Συρματόσχοινο 7x7, Ανοξειδωτο AISI 316
Wire rope 7x7, St. Steel AISI 316
Flexible - Suspension & positioning - Systems Control cables

nominal Ø mm	weight per kg/100 m	tensile strength N/mm ²	calculated breaking load kN	minimum breaking load kN
1,00	0,40	1570	0,67	0,56
1,50	0,90	1570	1,51	1,27
2,00	1,60	1570	2,69	2,25
2,50	2,50	1570	4,20	3,52
3,00	3,50	1570	6,05	5,07
3,50	4,82	1570	8,24	6,90
4,00	6,30	1570	10,70	9,01
5,00	9,80	1570	16,80	14,08
6,00	14,20	1570	24,20	20,28
7,00	19,30	1570	32,90	27,60
8,00	25,20	1570	430,00	36,05
10,00	39,30	1570	672,00	56,30
12,00	56,60	1570	920,00	81,10

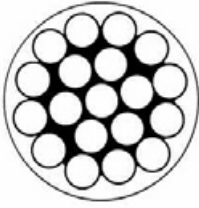
**11-2403**

Συρματόσχοινο επενδεδυμένο, λευκό ή μαύρο, 1x19, Ανοξειδωτο AISI 316
 Wire rope PVC coated, white or black, 1x19, St. Steel AISI 316
 Stiff - Guardrails

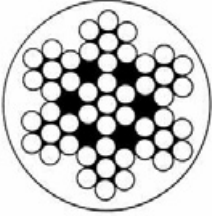

Συρματόσχοινο επενδεδυμένο, λευκό ή μαύρο, 7x7, Ανοξειδωτο AISI 316
 Wire rope PVC coated, white or black, 7x7, St. Steel AISI 316
 Very flexible - Guardrails

wire rope Ø mm	nominal Ø mm	transparent	white	black
2	3	<input checked="" type="checkbox"/>	<input checked="" type="checkbox"/>	
3	5		<input checked="" type="checkbox"/>	
4	6		<input checked="" type="checkbox"/>	
4	8		<input checked="" type="checkbox"/>	<input checked="" type="checkbox"/>
5	8		<input checked="" type="checkbox"/>	<input checked="" type="checkbox"/>
6	8		<input checked="" type="checkbox"/>	
6	9		<input checked="" type="checkbox"/>	<input checked="" type="checkbox"/>
8	10		<input checked="" type="checkbox"/>	
8	12		<input checked="" type="checkbox"/>	

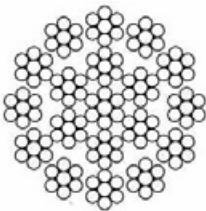
**11-2405**

Συρματόσχοινο ασύστροφο 18x7 + WSC 1570 N/mm² RHOL, Ανοξειδωτο AISI 316
 Wire rope, no rotate, 18x7 + WSC 1570 N/mm² RHOL, St. Steel AISI 316

Ømm	MBL kN	CBL kN	Kg/1000m
4,00	8,24	10,88	64,30
5,00	12,87	17,00	100,50
6,00	18,54	24,47	144,70
8,00	32,96	43,51	257,30
10,00	51,50	67,98	402,00

48-0080-9609

Λιπαντικό σπειρώματος PTFE, Blue Wave
 Blue Wave PTFE lubricate



Το συρματόσχοινο και τα εξαρτήματά του στη Ναυτιλία

Wire rope marine accessories



02 Εντατήρες Rigging screws



Εντατήρες για babystay Babystay adjusters



11-25011 1

Εντατήρας για babystay, Wichard, Ανοξείδωτος AISI 316
Babystay adjuster with wheel & schackle, Wichard, St. Steel AISI 316

11-25012 2

Εντατήρας για babystay, Wichard, Ανοξείδωτος AISI 316
Babystay adjuster with handle, Wichard, St. Steel AISI 316

11-25013 3

Εντατήρας για babystay, Wichard, Ανοξείδωτος AISI 316
Babystay adjuster with handle, Wichard, St. Steel AISI 316

11-25014 4

Εντατήρας για babystay, Wichard, Ανοξείδωτος AISI 316
Babystay adjuster with handle, Wichard, St. Steel AISI 316

11-25015 5

Εντατήρας για babystay, Wichard, Ανοξείδωτος AISI 316
Babystay adjuster with ratchet, Wichard, St. Steel AISI 316



1



2



3



4



5

N°	Part #	Length pin to pin closed / open mm	Toggle length x width mm	Ø pin mm	Handling Kg	W.L. Kg	B.L. Kg	Ø stud mm	For wire Ø mm	Weight Kg
With wheel										
1	11-25011	250 / 310	15 x 20	12	1200	2800	5300	12	5/6/7	1,090
With handle										
2	11-25012	310 / 450	10 x 10	8	800	960	2400	8	4/5	0,802
3	11-25013	450 / 510	15 x 20	12	1200	2800	5100	12	5/6/7	1,268
4	11-25014	370 / 540	15 x 20	12	1200	2800	5000	12	5/6/7	1,390
With ratchet										
5	11-25015	360 / 520	17 x 22	12	2500	3200	6000	14	7/8/9	1,848
	11-25015	360 / 520	17 x 22	14	2500	3200	6700	14	7/8/9	1,856
	11-25015	415 / 615	18 x 25	16	3300	3200	9000	16	9/10	2,862

Πλεονεκτήματα

- Μεγάλο εύρος διαθέσιμων babystay ρυθμιστών
- Διατίθεται με τροχό, λαβή ή καστάνια
- Εργονομικό και άνετο στη χρήση
- Εύκολο στην εγκατάσταση και την απεγκατάσταση
- Ανθεκτικό σε υψηλά φορτία
- Ιδανικό για τη χρήση flying sail (Solent jib ή φλόκο θυέλλης)
- Βελτιστοποιεί την απόδοση του γιούτ
- Διαθέσιμο μοντέλο μεγάλης διαδρομής

Benefits

- Large range of babystay adjusters
- Available with wheel, handle or ratchet
- Ergonomic and comfortable to use
- Easy to install and dismantle
- Forged body and snap hook
- Resistant to high loads
- Perfect for setting a flying sail (solent jib or storm jib)
- Optimizes yacht performance
- Long travel model available

Εντατήρες επιτόνου Backstay adjusters



11-25016

1

Εντατήρας επιτόνου, Wichard,
Ανοξείδωτος AISI 316
Backstay adjuster with wheel, Wichard,
St. Steel AISI 316

11-25017

2

Εντατήρας επιτόνου, Wichard,
Ανοξείδωτος AISI 316
Backstay adjuster with handle, Wichard,
St. Steel AISI 316

11-25018

3

Εντατήρας επιτόνου, Wichard,
Ανοξείδωτος AISI 316
Backstay adjuster with ratchet, Wichard,
St. Steel AISI 316



1



2



3

N°	Part #	Length pin to pin Closed/open mm	Toggle length x width mm	Ø pin mm	Handling mm	W.L. Kg	B.L. Kg	Ø Stud mm	For wire Ø mm	Weight Kg
With wheel										
1	11-25016	350 / 520	15 x 20	12	1200	2800	5300	12	5/6/7	1,128
With handle										
2	11-25017	350 / 520	15 x 20	12	1200	2800	5300	12	5/6/7	1,306
With ratchet										
3	11-25018	440 / 660	17 x 22	12	2500	3200	5000	14	7/8/9	2,052
	11-25018	440 / 660	17 x 22	14	2500	4400	6700	14	7/8/9	2,088
	11-25018	505 / 755	18 x 25	16	3300	5600	9000	16	9/10	3,264

WL: working load - BL: breaking load

Πλεονεκτήματα

- Διατίθεται με τροχό, λαβή ή κασάνια
- Εργονομικό και άνετο στη χρήση
- Βελτιστοποιεί την απόδοση
- Συμπαγές μέγεθος
- Ανθεκτικό σε υψηλά φορτία

Benefits

- Available with wheel, handle or ratchet
- Ergonomic and comfortable to use
- Optimizes rigging performance
- Compact size
- Forged body
- Resistant to high loads

Εντατήρες επιτόνου Backstay adjusters



11-2503

Εντατήρας, επιτόνου, Olcese Ricci,
Ανοξείδωτος AISI 316
Rigging screw, Olcese Ricci,
St. Steel AISI 316

	11-2503-8	11-2503-10	11-2503-12
b Διάμετρος / Diameter	8	10	12
c	18	22	30
d	8	10	12
Διαδρομή / Distance	130	150	175
L Κλειστό / Closed	290	350	420
Βάρος / Weight	1,00	1,85	2,90
Όριο χρήσης / Working load (kg)	600	950	1300
Όριο θραύσης / Braking load (kg)	3000	4750	6500

Design features:

- bronze nut and parts resistant stainless steel
- offset by shooting balls with stainless steel seats
- Power supply 150:1

Εντατήρες Rigging screws



11-2101

Εντατήρας μασίφ, Ανοξείδωτος AISI 316
Rigging screw, solid, St. Steel AISI 316

Ø Σπειρώματος / Thread:

M4	M10	M20
M5	M12	M22
M6	M14	M24
M8	M16	



11-2102

Εντατήρας με άκρα πύρο - πύρο, Blue Wave, Ανοξείδωτος AISI 316
Rigging screw, fork - fork, Blue Wave, St. Steel AISI 316

Ø Σπειρώματος / Thread:

M5	M8	M12	M16	M22
M6	M10	M14	M20	M24



11-2103

Εντατήρας με σπαστά άκρα, Blue Wave, Ανοξείδωτος AISI 316
Rigging screw, toggle - terminal, Blue Wave, St. Steel AISI 316

Ø Σπειρώματος / Thread:

M5	M8	M12	M16	M22
M6	M10	M14	M20	M24



11-2104

Εντατήρας με σταθερό άκρο - άκρο πρέσας, Blue Wave, Ανοξείδωτος AISI 316
Rigging screw, fork - terminal, Blue Wave, St. Steel AISI 316

Συμμ.-Σπειρ. Wire-Thread	Συμμ.-Σπειρ. Wire-Thread	Συμμ.-Σπειρ. Wire-Thread	Συμμ.-Σπειρ. Wire-Thread
Ø2-M5	Ø5-M8	Ø7-M12	Ø10-M20
Ø2,5-M5	Ø5-M10	Ø8-M12	Ø12-M20
Ø3-M6	Ø6-M10	Ø8-M16	Ø14-M22
Ø4-M6	Ø6-M12	Ø10-M16	Ø16-M24



11-21042

Εντατήρας με σπαστό άκρο - άκρο πρέσας, Blue Wave, Ανοξείδωτος AISI 316
Rigging screw, fork - terminal, Blue Wave, St. Steel AISI 316

Συμμ.-Σπειρ. Wire-Thread	Συμμ.-Σπειρ. Wire-Thread	Συμμ.-Σπειρ. Wire-Thread	Συμμ.-Σπειρ. Wire-Thread
Ø2-M5	Ø5-M8	Ø7-M12	Ø10-M20
Ø2,5-M5	Ø5-M10	Ø8-M12	Ø12-M20
Ø3-M6	Ø6-M10	Ø8-M16	
Ø4-M6	Ø6-M12	Ø10-M16	



**11-21041**

Εντατήρας με σώμα ανοιχτό bronz, σπαστό άκρο - άκρο πρέσας, Blue Wave, Ανοξειδωτος AISI 316
 Rigging screw, open chromed bronze body, toggle - terminal UNF, Blue Wave, St. Steel AISI 316

Συρμ.-Σπειρ. Wire-Thread	Συρμ.-Σπειρ. Wire-Thread	Συρμ.-Σπειρ. Wire-Thread	Συρμ.-Σπειρ. Wire-Thread
Ø3-M6	Ø5-M10	Ø7-M12	Ø10-M16
Ø4-M6	Ø6-M10	Ø8-M12	Ø10-M20
Ø5-M8	Ø6-M12	Ø8-M16	Ø12-M20

**11-2104-3**

Εντατήρας με άκρο πρέσας μίνι, Ανοξειδωτος AISI 316
 Rigging screw, small fork - terminal, St. Steel AISI 316

Συρμ.-Σπειρ. Wire-Thread
Ø3-M5
Ø4-M6
Ø5-M8
Ø6-M10

**11-2105**

Εντατήρας τύπου Νόρσμαν με σπαστό άκρο, Ανοξειδωτος AISI 316
 Rigging screw, toggle - swageless, St. Steel AISI 316

Συρμ.-Σπειρ. Wire-Thread	Συρμ.-Σπειρ. Wire-Thread	Συρμ.-Σπειρ. Wire-Thread	Συρμ.-Σπειρ. Wire-Thread
Ø3-M6	Ø5-M10	Ø8-M14	Ø12-M18
Ø4-M8	Ø6-M12	Ø10-M16	Ø14-M20

**11-2130**

Εντατήρας με σπαστό fork - άκρο πρέσας, άμεσης ρύθμισης, Blue Wave, Ανοξειδωτος AISI 316
 Rigging screw, toggle - wire terminal, quick race tuning, calibrated, Blue Wave, St. Steel AISI 316

Συρμ.-Σπειρ. Wire-Thread	Συρμ.-Σπειρ. Wire-Thread
Ø4-5/16"	Ø6-7/16"
Ø5-5/16"	Ø7-7/16"

**11-2106**

Εντατήρας με σώμα ανοιχτό και άκρα γάντζο - γάντζο, Ανοξειδωτος AISI 316
 Rigging screw with open body, hook - hook, St. Steel AISI 316

Ø Σπειρώματος / Thread:

M4	M6	M10	M16
M5	M8	M12	M20

**11-2107**

Εντατήρας με σώμα ανοιχτό και άκρα γάντζο - κρίκο, Ανοξειδωτος AISI 316
 Rigging screw with open body, hook - eye, St. Steel AISI 316

Ø Σπειρώματος / Thread:

M4	M6	M10	M16
M5	M8	M12	M20



11-2108

Εντατήρας με σώμα ανοιχτό και άκρα κρίκο - κρίκο, Ανοξείδωτος AISI 316
Rigging screw with open body, eye - eye, St. Steel AISI 316

Ø Σπειρώματος / Thread:

M4	M6	M10	M16
M5	M8	M12	M20



11-2120

Εντατήρας M5 για σωλήνα Ø10, Ανοξείδωτος AISI 316
Rigging screw M5 for pipe Ø10, St. Steel AISI 316



11-2114

Εντατήρας με σώμα Αλουμινίου και ανοξείδωτα άκρα γάντζο - γάντζο, σε μπλε και κόκκινο χρώμα
Rigging screw, with Aluminium body and St. Steel hooks, hook - hook, in blue and red colour

Ø Σπειρώματος / Thread:

M5	M6	M8	M10
----	----	----	-----

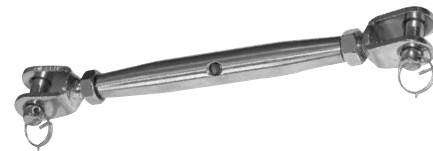

11-2115

Εντατήρας κολλητός με άκρα πύρο - πύρο, Ανοξείδωτος AISI 316
Rigging screw, jaw - jaw, St. Steel AISI 316

Ø Σπειρώματος / Thread:

M4	M8	M14
M5	M10	M16
M6	M12	M20



11-2116

Εντατήρας κολλητός με σώμα ανοιχτό και άκρα πύρο - πύρο, Ανοξείδωτος AISI 316
Rigging screw with open body, jaw - jaw, St. Steel AISI 316

Ø Σπειρώματος / Thread:

M4	M8	M14
M5	M10	M16
M6	M12	M20



11-2117

Εντατήρας με άκρα στριφτάρι - σκύλα, M12, Ανοξείδωτος AISI 316
Rigging screw with swiveled quick release, M12, St. Steel AISI 316

**11-22080**

Pelican hook, Blue Wave, Anoxeidwtos AISI 316
 Pelican hook, Blue Wave, St. Steel AISI 316

Ø Σπειρώματος / Thread:

M8	5/16"
----	-------

**11-22081**

Pelican hook, Wichard, Anoxeidwtos AISI 316
 Pelican hook, Wichard, St. Steel AISI 316

Ø Σπειρώματος / Thread:

M6	M8	M10
----	----	-----

**11-22082**

Pelican hook, Anoxeidwtos AISI 316
 Pelican hook, St. Steel AISI 316

Ø Σπειρώματος / Thread:

M6	M8	M10	M12
----	----	-----	-----

**11-22083**

Enatíthras Life Line, Wichard, Anoxeidwtos AISI 316
 Life Line hook, Wichard, St. Steel AISI 316

Ø Σπειρώματος / Thread:

M6	M8
----	----

**11-2100**

Σώμα εντατήρα, Blue Wave, Anoxeidwtos AISI 316
 St. Steel body, Blue Wave, St. Steel AISI 316

Μετρικό Σπείρωμα / Metric thread:

M5	M14	M27
M6	M16	M30
M8	M20	M36
M10	M22	
M12	M24	

UNF Σπείρωμα / UNF thread:

1/4"	7/16"	3/4"
5/16"	1/2"	7/8"
3/8"	5/8"	1"

**11-21001**

Σώμα εντατήρα, Blue Wave, Bronze
 Bronze body, Blue Wave

Μετρικό Σπείρωμα / Metric thread:

M5	M14	M27
M6	M16	M30
M8	M20	M36
M10	M22	
M12	M24	

UNF Σπείρωμα / UNF thread:

1/4"	7/16"	3/4"
5/16"	1/2"	7/8"
3/8"	5/8"	1"



03

Εξαρτήματα συρματόσχοινου Wire rope accessories



11-2201

Άκρο fork συρματόσχοινου,
τύπου Νόρμαν, Ανοξείδωτο AISI 316
Swageless fork terminal, St. Steel AISI 316

Για συρματόσχοινο / For wire rope:

Ø2	Ø7
Ø2,5	Ø8
Ø3	Ø10
Ø4	Ø12
Ø5	Ø14
Ø6	Ø16

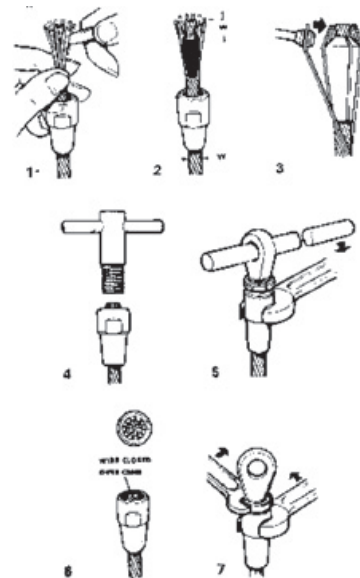

11-2203

Άκρο fork συρματόσχοινου,
αυτόματο swagless, Blue Wave,
Ανοξείδωτο AISI 316
Swageless fork terminal, Blue Wave,
St. Steel AISI 316

Για συρματόσχοινο / For wire rope:

Ø3	Ø7
Ø4	Ø8
Ø5	Ø10
Ø6	Ø12

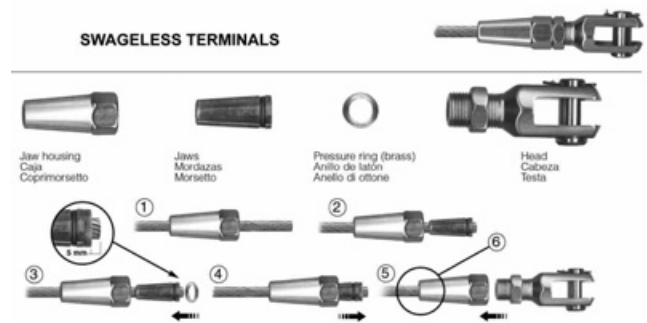

**11-2202**

Άκρο eye συρματόσχοινου, τύπου Νόρμαν,
Ανοξείδωτο AISI 316
Swageless eye terminal, St. Steel AISI 316

Για συρματόσχοινο / For wire rope:

Ø2	Ø7
Ø2,5	Ø8
Ø3	Ø10
Ø4	Ø12
Ø5	Ø14
Ø6	Ø16

**11-2204**

Άκρο eye συρματόσχοινου,
αυτόματο swagless, Blue Wave,
Ανοξείδωτο AISI 316
Swageless eye terminal, Blue Wave, St. Steel
AISI 316

Για συρματόσχοινο / For wire rope:

Ø3	Ø7
Ø4	Ø8
Ø5	Ø10
Ø6	Ø12

**11-2224**

Άκρο σπαστό fork, αυτόματο swageless,
Blue Wave, Ανοξείδωτο AISI 316
Toggle swageless terminal, Blue Wave,
St. Steel AISI 316

Για συρματόσχοινο / For wire rope:

Ø3	Ø7
Ø4	Ø8
Ø5	Ø10
Ø6	Ø12

**11-2212**

Άκρο αυτόματο swageless συρματόσχοινου,
με δεξί/αριστερό σπειρώμα, Blue Wave,
Ανοξείδωτο AISI 316
Swageless thread terminal metric, right/left,
Blue Wave, St. Steel AISI 316

Συμμ.-Σπείρ. Wire-Thread	Συμμ.-Σπείρ. Wire-Thread
Ø3-M5	Ø7-M10
Ø3-M6	Ø7-M12
Ø4-M6	Ø7-M14
Ø4-M8	Ø8-M14
Ø5-M8	Ø8-M16
Ø5-M10	Ø10-M16
Ø6-M10	Ø12-M20

**11-2205**

Άκρο fork πρέσας, Blue Wave,
Ανοξείδωτο AISI 316
Welded fork terminal, Blue Wave,
St. Steel AISI 316

Για συρματόσχοινο / For wire rope:

Ø2,5	Ø7
Ø3	Ø8
Ø4	Ø10
Ø5	Ø12
Ø6	Ø14

**11-2206**

Άκρο eye πρέσας, Blue Wave,
Ανοξείδωτο AISI 316
Eye terminal, Blue Wave,
St. Steel AISI 316

Για συρματόσχοινο / For wire rope:

Ø2,5	Ø7
Ø3	Ø8
Ø4	Ø10
Ø5	Ø12
Ø6	Ø14





11-2207

Άκρο πρέσας με σπείρωμα, αριστερό - δεξί, Blue Wave, Ανοξειδωτο AISI 316
Thread terminal metric, left - right, Blue Wave, St. Steel AISI 316

Συρμ.-Σπείρ. Wire-Thread	Συρμ.-Σπείρ. Wire-Thread	Συρμ.-Σπείρ. Wire-Thread
Ø2,5-M5	Ø6-M10	Ø8-M16
Ø3-M6	Ø6-M12	Ø10-M16
Ø4-M6	Ø7-M12	Ø10-M20
Ø4-M8	Ø7-M14	Ø12-M20
Ø5-M8	Ø8-M12	Ø14-M22
Ø5-M10	Ø8-M14	



11-2218

Άκρο πρέσας με θηλυκό σπείρωμα, αριστερό - δεξί, Blue Wave, Ανοξειδωτο AISI 316
Inside thread terminal metric, left - right, Blue Wave, St. Steel AISI 316

Διαστάσεις / Dim:

Ø2,5-M4 / 15 thread	Ø6-M8 / 25 thread
Ø3-M5 / 20 thread	Ø6-M8 / 40 thread
Ø3-M5 / 35 thread	Ø6-M10 / 40 thread
Ø4-M6 / 20 thread	Ø7-M10 / 40 thread
Ø4-M6 / 35 thread	Ø8-M10 / 40 thread
Ø5-M6 / 20 thread	Ø10-M12 / 40 thread
Ø5-M6 / 35 thread	Ø10-M16 / 40 thread
Ø5-M8 / 40 thread	



11-2223

Άκρο ball-eye, Ανοξειδωτο AISI 316
Ball eye terminal, St. Steel AISI 316

Για συρματόσχοινο / For wire rope:

Ø5
Ø6
Ø7
Ø8



11-2209

Άκρο ball πρέσας, Blue Wave, Ανοξειδωτο AISI 316
Ball terminal, Blue Wave, St. Steel AISI 316

Για συρματόσχοινο / For wire rope:

Ø3	Ø7
Ø4	Ø8
Ø5	Ø10
Ø6	Ø12



11-22091

Ροδέλα άκρου ball, Ανοξειδωτο AISI 316
Wisher for ball terminal, St. Steel AISI 316

Για συρματόσχοινο / For wire rope:

Ø3	Ø7
Ø4	Ø8
Ø5	Ø10
Ø6	Ø12



11-2210

Άκρο fork σπαστό πρέσας, Blue Wave, Ανοξειδωτο AISI 316
Toggle terminal, Blue Wave, St. Steel AISI 316

Για συρματόσχοινο / For wire rope:

Ø3	Ø8
Ø4	Ø10
Ø5	Ø12
Ø6	Ø14
Ø7	Ø16



**11-2211**

Άκρο eye με εξωτερικό σπείρωμα, αριστερό - δεξί, Blue Wave, Ανοξείδωτο AISI 316
Thred eye terminal, drilled for split pin, left - right, Blue Wave, St. Steel AISI 316

Ø Σπειρώματος / Thread:

M5	M10	M20
M6	M12	M22
M8	M14	M24

Ø Σπειρώματος UNF / Thread UNF:

1/4"	7/16"	3/4"
5/16"	1/2"	7/8"
3/8"	5/8"	1"

**11-2213**

Άκρο fork σπαστό με εξωτερικό σπείρωμα, αριστερό - δεξί, Ανοξείδωτο AISI 316
Thred toggles terminal, drilled for split pin, left - right, St. Steel AISI 316

Ø Σπειρώματος / Thread:

M5	M10	M20
M6	M12	M22
M8	M14	M24

Ø Σπειρώματος UNF / Thread UNF:

1/4"	7/16"	3/4"
5/16"	1/2"	7/8"
3/8"	5/8"	1"

**11-2214**

Άκρο hook πρέσας, Blue Wave, Ανοξείδωτο AISI 316
Hook terminal, Blue Wave, St. Steel AISI 316

Για συρματόσχοινο / For wire rope:

Ø2
Ø2,5
Ø3
Ø4
Ø5

**11-2215**

Άκρο fork, Blue Wave, με εξωτερικό σπείρωμα, Ανοξείδωτο AISI 316
Welded thread fork metric terminal, Blue Wave, St. Steel AISI 316

Ø Σπειρώματος / Thread:

M5	M10	M20
M6	M12	M22
M8	M14	M24

Ø Σπειρώματος UNF / Thread UNF:

1/4"	7/16"	3/4"
5/16"	1/2"	7/8"
3/8"	5/8"	1"

**11-2216**

Άκρο "T" πρέσας, Blue Wave, Ανοξείδωτο AISI 316
"T" terminal, Blue Wave, St. Steel AISI 316

Για συρματόσχοινο / For wire rope:

Ø2	Ø4	Ø7
Ø2,5	Ø5	Ø8
Ø3	Ø6	Ø10

**11-2222**

Βάση για άκρο "T", Blue Wave, Ανοξείδωτο AISI 316
Base for "T" terminal, Blue Wave, St. Steel AISI 316

Για συρματόσχοινο / For wire rope:

Ø2-Ø3
Ø4-Ø5
Ø6-Ø7
Ø8-Ø10





11-2217

Άκρο domehead πρέσας, Blue Wave,
Ανοξείδωτο AISI 316
Domehead terminal, Blue Wave,
St. Steel AISI 316

Για συρματόσχοινο / For wire rope:

Ø3	Ø8
Ø4	Ø10
Ø5	Ø12
Ø6	



11-2219

Άκρο πρέσας Life Line, Blue Wave,
Ανοξείδωτο AISI 316
Life Line terminal, Blue Wave,
St. Steel AISI 316

Για συρματόσχοινο / For wire rope:

Ø3
Ø4



11-2220

Άκρο μάπα πρέσας, Blue Wave,
Ανοξείδωτο AISI 316
Rope terminal, Blue Wave,
St. Steel AISI 316

Για συρματόσχοινο / For wire rope:

Ø3
Ø4
Ø5



11-2221

Άκρο κλειδί πρέσας, Blue Wave,
Ανοξείδωτο AISI 316
Welded fork terminal, Blue Wave,
St. Steel AISI 316

Για συρματόσχοινο / For wire rope:

Ø4
Ø5
Ø6



11-2301

Ροδάτσα, Ανοξείδωτη AISI 316
Thimble, St. Steel AISI 316

Για συρματόσχοινο / For wire rope:

Ø2	Ø14	Ø30
Ø3	Ø16	Ø32
Ø4	Ø18	Ø36
Ø5	Ø20	Ø38
Ø6	Ø22	Ø40
Ø8	Ø24	Ø42
Ø10	Ø26	Ø44
Ø12	Ø28	



11-2306

Ροδάτσα πλαστική
Plastic thimble

Για συρματόσχοινο / For wire rope:

Ø4	Ø8	Ø14	Ø20
Ø5	Ø10	Ø16	Ø22
Ø6	Ø12	Ø18	Ø24

**11-2303**

Σφικτήρας συρματόσχοινου "U",
Ανοξείδωτος AISI 316
Wire rope clip, St. Steel AISI 316

Για συρματόσχοινο / For wire rope:

Ø2	Ø6	Ø16
Ø2,5	Ø8	Ø19
Ø3	Ø10	Ø20
Ø4	Ø12	Ø22
Ø5	Ø14	Ø24

**11-2304**

Σφικτήρας συρματόσχοινου διπλός,
Ανοξείδωτος AISI 316
Double wire rope clip, St. Steel AISI 316

Για συρματόσχοινο / For wire rope:

Ø2	Ø6
Ø3	Ø8
Ø4	Ø10
Ø5	

**11-2305**

Ταλουρίτ Χαλκού
Copper swage sleeve

Για συρματόσχοινο / For wire rope:

Ø1,5	Ø6
Ø2	Ø8
Ø2,5	Ø10
Ø3	Ø12
Ø4	Ø14
Ø5	

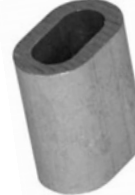
**11-2308**

Ταλουρίτ Αλουμινίου
Aluminium swage sleeve

Για συρματόσχοινο / For wire rope:

Ø1,5	Ø6
Ø2	Ø8
Ø2,5	Ø10
Ø3	Ø12
Ø4	Ø14
Ø5	

**11-2310**

Στρογγυλό ταλουρίτ Αλουμινίου
Round Aluminium sleeve

Για συρματόσχοινο / For wire rope:

Ø1,5	Ø6
Ø2	Ø8
Ø2,5	Ø10
Ø3	Ø12
Ø4	Ø14
Ø5	

**11-2309**

Ταλουρίτ Ανοξείδωτο
Inox swage sleeve

Για συρματόσχοινο / For wire rope:

Ø1,5	Ø6
Ø2	Ø8
Ø2,5	Ø10
Ø3	Ø12
Ø4	Ø14
Ø5	



11-2302

Ροδότσα ασφαλείας,
Ανοξείδωτη AISI 316
Security thimble, St. Steel AISI 316

Για συρματόσχοινο / For wire rope:

Ø6-Ø10
Ø12-Ø16



11-2307

Ταλουρίτ για σχοινί, Ανοξείδωτο AISI 316
Rope clamp, St. Steel AISI 316

Για σχοινί / For rope:

8-10
12-14
16-20



11-2109

Τόγλη επιμήκυνσης εντατήρα,
Ανοξείδωτη AISI 316
Toggle for rigging screw,
St. Steel AISI 316

Για εντατήρα / For rigging screw:

Ø5	Ø14
Ø6	Ø16
Ø8	Ø18
Ø10	Ø20
Ø12	Ø24



11-2119

Τόγλη επιμήκυνσης εντατήρα,
Ανοξείδωτη AISI 316
Toggle for rigging screw,
St. Steel AISI 316

Για εντατήρα / For rigging screw:

Ø5	Ø14
Ø6	Ø16
Ø8	Ø18
Ø10	Ø20
Ø12	Ø24



11-2118

Πύρος με κρίκο και μπίλια,
Ανοξείδωτος AISI 316
Fast pin with ring, St. Steel AISI 316

Διαστάσεις / Dim:

Ø5x25
Ø6x25
Ø8x25
Ø8x38



11-2110

Πύρος εντατήρα, Blue Wave,
Ανοξείδωτος AISI 316
Clevis pin, Blue Wave, St. Steel AISI 316

Διαστάσεις / Dim:

Ø5x15	Ø12,7x28	Ø22x55
Ø6x7	Ø14x33	Ø22x58
Ø6,35x16	Ø14x37	Ø25x63
Ø8x18	Ø16x34	Ø25,4x56
Ø8,x21	Ø16x40	Ø28x73
Ø9,5x23	Ø19x45	Ø32x83
Ø11x26	Ø19x49	Ø35x88
Ø12x 28	Ø22x46	

**11-21111**

Ασφάλεια πύρου εντατήρα, Blue Wave,
Ανοξείδωτη AISI 316
"G" ring, Blue Wave, St. Steel AISI 316

Διαστάσεις / Dim:

Ø11	Ø15	Ø19	Ø23
-----	-----	-----	-----

**11-2112**

Πύρος εντατήρα, Ανοξείδωτος AISI 316
Clevis pin, St. Steel AISI 316

Διαστάσεις / Dim:

Ø4x11	Ø6x21	Ø8x28
Ø4x16	Ø6x25	Ø9,5x22
Ø5x14	Ø6x32	Ø9,5x26
Ø5x11	Ø6x41	Ø10x26
Ø5x17	Ø8x17	Ø11x25
Ø6x11	Ø8x20	Ø12x26
Ø6x16	Ø8x23	Ø14x36

**11-2113**

Ασφάλεια πύρου εντατήρα Smart Pin,
Blue Wave, Ανοξείδωτη AISI 316
Smart Pin, split pin on velcro one-wrap® strap,
Blue Wave, St. Steel AISI 316

The smart pins are a fast and new way of securing open body rigging screws. Simply put the pin attached to the Velcro strap into the split hole and secure the Velcro strap around the rigging screw.

Διαστάσεις / Dim:

Ø2,0 / M6
Ø2,5 / M8-M10
Ø3,2 / M12
Ø4,0 / M16-M20





11-2600

Εξαρτήριζα, Ανοξείδωτη AISI 316
Stay adjuster, St. Steel AISI 316

Διαστάσεις / Dim:

Ø8 - L180x2

Ø10 - L200x2,5

Ø12 - L250x3



11-2601

Εξαρτήριζα στενή, Ανοξείδωτη AISI 316
Stay adjuster, St. Steel AISI 316

Διαστάσεις / Dim:

Ø6 - L100

Ø6 - L120

Ø6 - L150

Ø6 - L180



11-2602

Εξαρτήριζα διπλή, Blue Wave,
Ανοξείδωτη AISI 316
Double strip shackless key pin, Blue Wave,
St. Steel AISI 316

Διαστάσεις / Dim:

Ø5 - L100

Ø6 - L120



11-2604

Εξαρτήριζα διπλή, Ανοξείδωτη AISI 316
Double stay adjuster, St. Steel AISI 316

Διαστάσεις / Dim:

Ø6 - L120



11-2605

Εξαρτήριζα διπλή, Ανοξείδωτη AISI 316
Double stay adjuster, St. Steel AISI 316

Διαστάσεις / Dim:

L120

Το συρματόσχοινο
και τα εξαρτήματά του
στη Διακόσμηση
Wire Design System



04

WDS εξαρτήματα συρματόσχοινου

WDS fittings



11-3001

WDS άκρο πρέσας eye, Blue Wave,
Ανοξείδωτο AISI 316
WDS eye terminal, Blue Wave,
St. Steel AISI 316

Για συρματόσχοινο / For wire rope:

Ø3	Ø5
Ø4	Ø6



11-3010

WDS άκρο πρέσας domehead,
Blue Wave, Ανοξείδωτο AISI 316
WDS domehead terminal,
Blue Wave, St. Steel AISI 316

Για συρματόσχοινο / For wire rope:

Ø3	Ø5
Ø4	Ø6



11-3011

WDS άκρο πρέσας cone, Blue Wave,
Ανοξείδωτο AISI 316
WDS cone terminal, Blue Wave,
St. Steel AISI 316

Για συρματόσχοινο / For wire rope:

Ø3	Ø5
Ø4	Ø6



11-3041

WDS άκρο πρέσας fork κολλητό,
Blue Wave, Ανοξείδωτο AISI 316
WDS fork terminal welded,
Blue Wave, St. Steel AISI 316

Για συρματόσχοινο / For wire rope:

Ø3	Ø6
Ø4	Ø8
Ø5	Ø10



11-3009

WDS άκρο πρέσας fork τόνου,
Blue Wave, Ανοξείδωτο AISI 316
WDS fork terminal machined,
Blue Wave, St. Steel AISI 316

Για συρματόσχοινο / For wire rope:

Ø3	Ø5
Ø4	Ø6



11-3007

WDS άκρο πρέσας - σπειρώματος,
Blue Wave, Ανοξείδωτο AISI 316
WDS thread terminal,
Blue Wave, St. Steel AISI 316

Συρμ.-Σπειρ. Wire-Thread	Συρμ.-Σπειρ. Wire-Thread	Συρμ.-Σπειρ. Wire-Thread
Ø3-M5	Ø5-M6	Ø8-M10
Ø4-M6	Ø6-M8	Ø10-M12





11-3072

WDS άκρο με άλεν, Blue Wave, Ανοξείδωτο AISI 316
WDS dropnose terminal, Blue Wave, St. Steel AISI 316

Συρμ.-Σπειρ. Wire-Thread	Συρμ.-Σπειρ. Wire-Thread
Ø3-M5	Ø5-M6
Ø4-M6	Ø6-M8



11-3060

WDS άκρο με ελατήριο, Blue Wave, Ανοξείδωτο AISI 316
WDS terminal with spring, Blue Wave, St. Steel AISI 316

Για συρματόσχοινο / For wire rope:

Ø3	Ø4
----	----



11-3052

WDS άκρο light swageless, Blue Wave, Ανοξείδωτο AISI 316
WDS swageless terminal, Blue Wave, St. Steel AISI 316

Συρμ.-Σπειρ. Wire-Thread	Συρμ.-Σπειρ. Wire-Thread
Ø3-M5	Ø4-M6



11-3063

WDS άκρο swivel, πρέσας - σπειρώματος, με ελεύθερη περιστροφή, Blue Wave, Ανοξείδωτο AISI 316
WDS swivel thread terminal with free turn, Blue Wave, St. Steel AISI 316

Συρμ.-Σπειρ. Wire-Thread	Συρμ.-Σπειρ. Wire-Thread
Ø3-M5	Ø5-M6
Ø4-M6	Ø6-M8



11-3008

WDS άκρο πρέσας - σπειρώματος, με εσωτερικό σπείρωμα, Blue Wave, Ανοξείδωτο AISI 316
WDS inside thread terminal, Blue Wave, St. Steel AISI 316

Συρμ.-Σπειρ. Wire-Thread	Συρμ.-Σπειρ. Wire-Thread
Ø3-M5	Ø5-M6
Ø4-M6	Ø6-M8



11-3029

WDS άκρο domehead, με εσωτερικό σπείρωμα, Blue Wave, Ανοξείδωτο AISI 316
WDS inside thread domehead terminal, Blue Wave, St. Steel AISI 316

Ø Σπειρώματος / Thread:

M5	M6	M8
----	----	----



11-3042

WDS άκρο fork, κολλητό, με εσωτερικό σπείρωμα, Blue Wave, Ανοξείδωτο AISI 316
WDS inside thread fork welded terminal, Blue Wave, St. Steel AISI 316

Ø Σπειρώματος / Thread:

M5	M6	M6 XL	M8
----	----	-------	----



11-3027

WDS άκρο fork τόννου, με εσωτερικό σπείρωμα, Blue Wave, Ανοξείδωτο AISI 304
WDS inside thread fork machined terminal, Blue Wave, St. Steel AISI 304

Ø Σπειρώματος / Thread:

M5	M6	M8
----	----	----



**11-3013**

WDS άκρο fork τόνου, με εξωτερικό σπείρωμα, Blue Wave, Ανοξείδωτο AISI 304
 WDS thread fork machined terminal, Blue Wave, St. Steel AISI 304

Ø Σπειρώματος / Thread:

M5	M6	M8
----	----	----

**11-3043**

WDS άκρο fork, κολλητό, με εξωτερικό σπείρωμα, Blue Wave, Ανοξείδωτο AISI 316
 WDS thread fork welded terminal, Blue Wave, St. Steel AISI 316

Ø Σπειρώματος / Thread:

M5	M8
M6	M10
M6 XL	M12

**11-3004**

WDS άκρο eye, με εξωτερικό σπείρωμα, Blue Wave, Ανοξείδωτο AISI 316
 WDS thread eye terminal, Blue Wave, St. Steel AISI 316

Ø Σπειρώματος / Thread:

M5	M6	M8
----	----	----

**11-3064**

WDS άκρο eye, με σπείρωμα ξυλόβιδας, Blue Wave, Ανοξείδωτο AISI 304
 WDS screw eye terminal, Blue Wave, St. Steel AISI 304

Διαστάσεις / Dim:

Ø5xL24	Ø6xL35
--------	--------

**11-3020**

WDS άκρο με διπλό σπείρωμα, Blue Wave, Ανοξείδωτο AISI 304
 WDS doubleal thread screw terminal, Blue Wave, St. Steel AISI 304

Διαστάσεις / Dim:

Ø5xL70	Ø6xL80	Ø8xL90
--------	--------	--------

**11-3065**

WDS διπλός πύρος με σπείρωμα, Blue Wave, Ανοξείδωτος AISI 316
 WDS double threaded pin, Blue Wave, St. Steel AISI 316

Διαστάσεις / Dim:

M5xL60	M6xL65	M8xL75
--------	--------	--------

**11-3066**

WDS πύρος με σπείρωμα, Blue Wave, Ανοξείδωτος AISI 316
 WDS threaded pin, Blue Wave, St. Steel AISI 316

Διαστάσεις / Dim:

M5xL38	M6xL48	M8xL52
--------	--------	--------

**11-3014**

WDS σώμα εντατήρα, Blue Wave, Ανοξείδωτο AISI 316
 WDS body, Blue Wave, St. Steel AISI 316

Ø Σπειρώματος / Thread:

M5	M6	M8	M10	M12
----	----	----	-----	-----





11-3025

WDS ροδέλα, Blue Wave, Ανοξείδωτη AISI 316
WDS cover disk, Blue Wave, St. Steel AISI 316

Διαστάσεις / Dim (IdxOdxTh):

Ø5,5x15x3 Ø6,5x20x4 Ø8,5x25x4



11-3017

WDS βίδα σύνθεσης (ISO 7380), Blue Wave, Ανοξείδωτη AISI 304
WDS domehead screw (ISO 7380), Blue Wave, St. Steel AISI 304

Διαστάσεις / Dim:

M5xL30 M6xL35 M8xL40



11-3022

WDS άκρο Stop-End, με εσωτερικό σπειρώμα, Blue Wave, Ανοξείδωτο AISI 316
WDS inside thread domehead terminal Stop-End, Blue Wave, St. Steel AISI 316

Ø Σπειρώματος / Thread:

M5 M6 M8 M10



11-3067

WDS περιστρεφόμενος σύνδεσμος, Blue Wave, Ανοξείδωτος AISI 316
WDS flexible net clip, Blue Wave, St. Steel AISI 316

Για συρματόσχοινο / For wire rope:

Ø3 Ø4 Ø5 Ø6



11-3016

WDS σταυρός με άλεν τυφλό, Blue Wave, Ανοξείδωτος AISI 304
WDS net clip, Blue Wave, St. Steel AISI 304

Για συρματόσχοινο / For wire rope:

Ø3 Ø4 Ø5 Ø6 Ø8



11-3016-1

WDS σταυρός με άλεν τυφλό, Ανοξείδωτος AISI 316
WDS net clip, St. Steel AISI 316

Για συρματόσχοινο / For wire rope:

Ø3 Ø4 Ø5 Ø6 Ø8

**11-3028**

WDS σταυρός με άλεν,
 διαμπερές σπείρωμα, Blue Wave,
 Ανοξείδωτος AISI 304
 WDS net clip (through going thread),
 Blue Wave, St. Steel AISI 304

Για συρματόσχοινο / For wire rope:

Ø3	Ø4	Ø5	Ø6	Ø8
----	----	----	----	----

**11-3028-1**

WDS σταυρός με άλεν,
 διαμπερές σπείρωμα,
 Ανοξείδωτος AISI 316
 WDS net clip (through going thread),
 St. Steel AISI 316

Για συρματόσχοινο / For wire rope:

Ø3	Ø4	Ø5	Ø6	Ø8
----	----	----	----	----

**11-3015**

WDS βάση ραφιού, Blue Wave,
 Ανοξείδωτη AISI 304
 WDS stopper, Blue Wave,
 St. Steel AISI 304

Για συρματόσχοινο / For wire rope:

Ø3	Ø4	Ø5	Ø6	Ø8
----	----	----	----	----

**11-3015-1**

WDS βάση ραφιού, Ανοξείδωτη AISI 316
 WDS stopper, St. Steel AISI 316

Για συρματόσχοινο / For wire rope:

Ø3	Ø4	Ø5	Ø6	Ø8
----	----	----	----	----

**11-3015-2**

WDS βάση ραφιού, Ανοξείδωτη AISI 316
 WDS stopper, St. Steel AISI 316

Για συρματόσχοινο / For wire rope:

Ø3-Ø4	Ø5-Ø6
-------	-------

**11-3018**

WDS stop ball, Blue Wave,
 Ανοξείδωτο AISI 304
 WDS stop ball, Blue Wave,
 St. Steel AISI 304

Για συρματόσχοινο / For wire rope:

M4 / Ø3-Ø15	M5 / Ø5-Ø20
M5 / Ø4-Ø20	M6 / Ø6-Ø25





11-3019

WDS μπίλια τερματική με σπείρωμα, Blue Wave, Ανοξείδωτο AISI 304
WDS ball with internal thread, Blue Wave, St. Steel AISI 304

Διαστάσεις / Dim:

M5-15	M6-20
M5-20	M8-25

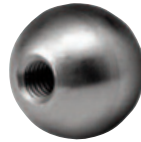

11-3030

WDS μπίλια με διαμπερές σπείρωμα, Blue Wave, Ανοξείδωτη AISI 304
WDS ball for through going thread, Blue Wave, St. Steel AISI 304

Διαστάσεις / Dim:

M5-15	M6-20
M5-20	M8-25

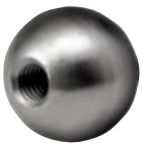

11-3030-1

WDS μπίλια με διαμπερές σπείρωμα, Ανοξείδωτη AISI 304
WDS ball for through going thread, St. Steel AISI 304

Διαστάσεις / Dim:

M5-15	M6-20
-------	-------



11-3024

WDS μπίλια για domehead άκρο, Blue Wave, Ανοξείδωτη AISI 304
WDS ball for domehead terminal, St. Steel AISI 304

Για άκρο συρματόσχοιου / For terminal:

Ø3-Ø15	Ø5-Ø20
Ø4-Ø20	Ø6-Ø25



11-3068

WDS φλάντζα άκρου μεταβλητής γωνίας, Blue Wave, Ανοξείδωτη AISI 316
Sleeve for WDS ball, Blue Wave, St. Steel AISI 316

Για άκρο συρματόσχοιου / For terminal:

No 1: Ø3 - Ø4 - Ø5
No 2: Ø6



11-3069

WDS μπίλια άκρου μεταβλητής γωνίας, Blue Wave, Ανοξείδωτη AISI 316
WDS flexible anle hinge, Blue Wave, St. Steel AISI 316

Για άκρο σπειρώματος / For thread terminal:

M5	M6	M8
----	----	----



1



11-3031

1. WDS πρέσα, ηλεκτρική, Blue Wave
WDS crimping pressing tool, electric, Blue Wave



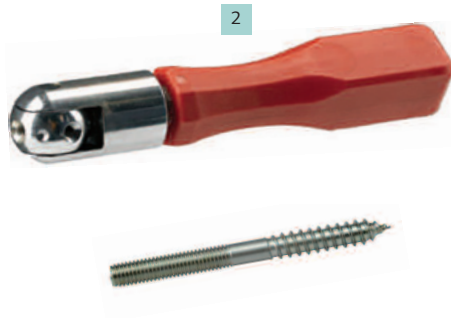

2. WDS εργαλείο για μπουζονοστρίφωνα, Blue Wave
 WDS Dual thread screw tool, Blue Wave



05

Σύστημα ανάρτησης αναρριχώμενων φυτών Green Line post



11-3150

Σύστημα ανάρτησης αναρριχώμενων φυτών Green Line,
 Blue Wave, Ανοξείδωτη AISI 316
 Green Line post, Blue Wave, St. Steel AISI 316

G1	G2	D1	D2	D3	L1	L2	L3	L4	LOAD	KG/100	PACK
M8	M6	90	16	6	95	30	19	9	100	19,4	1

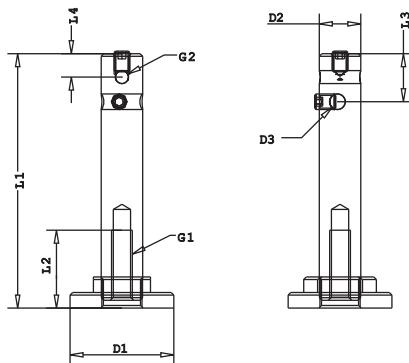

06

Σύστημα κουρτίνας “Υ” “Υ” System curtain anchor

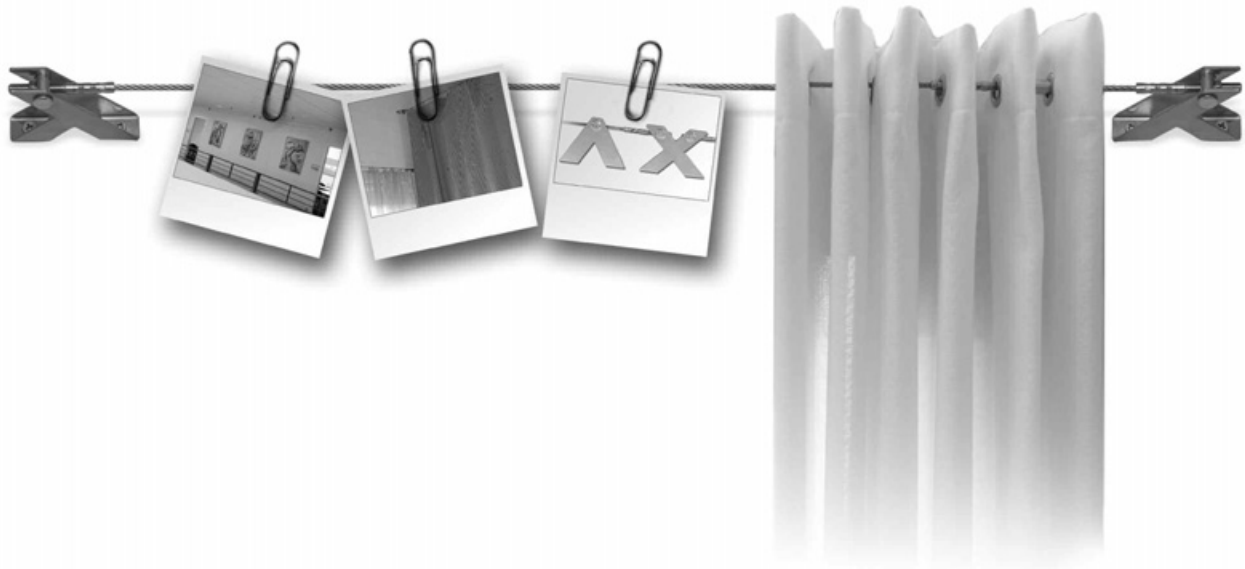

11-3101

WDS μεσαία βάση “X”
για συρματόσχοινο Ø3, Blue Wave,
Ανοξείδωτη AISI 304
WDS curtain anchor “X”,
double headed clevis pin,
for Ø3 wire rope,
Blue Wave, St. Steel AISI 304



11-3102

WDS βάση άκρης “V”
για συρματόσχοινο Ø3, Blue Wave,
Ανοξείδωτη AISI 304
WDS curtain anchor “V”,
double headed clevis pin,
for Ø3 wire rope,
Blue Wave, St. Steel AISI 304



11-3103

WDS βάση άκρης “Y”
για συρματόσχοινο Ø3, Blue Wave,
Ανοξείδωτη AISI 304
WDS curtain anchor “Y”,
double headed clevis pin,
for Ø3 wire rope,
Blue Wave, St. Steel AISI 304



30, Methonis
& Mavromichali str.
18545 Piraeus, Greece
tel.: +30 210 4205890
fax: +30 210 4205892
e-mail: info@theodosiadis.gr
www.theodosiadis.gr